

no frame concentra flex 17 e

linha de luminárias embutidas ou aplicadas, em perfil de alumínio extrudado, para tecnologia led. permite instalação em forro de gesso, alvenaria, laje, marcenaria ou trilho, com opções de fechos fixos e orientáveis. sua principal característica é o excelente controle antiofuscamento, eficiência luminosa e tamanhos reduzidos.

informações técnicas

fonte de luz
LED integrado

IRC
alto índice de reprodução de cor (irc>90 | r9>60)

vida útil
50.000h

potência (W), fecho, temperatura de cor (K),
fluxo nominal (lm nominal), fluxo útil (lm útil)

W		K	lm nominal	lm útil
6	concentrado	2700		
6	médio	2700		
6	aberto	2700		
6	concentrado	3000	715	482
6	médio	3000	715	554
6	aberto	3000	715	477
6	concentrado	4000		
6	médio	4000		
6	aberto	4000		
12	concentrado	2700		
12	médio	2700		
12	aberto	2700		
12	concentrado	3000	1290	824
12	médio	3000	1290	951
12	aberto	3000	1290	808
12	concentrado	4000		
12	médio	4000		
12	aberto	4000		

equipamentos

LED driver 700mA (incluso, ponto remoto)

controle

on/off
dim fphase
dim dali
dim 1-10V

instalação

forro de gesso

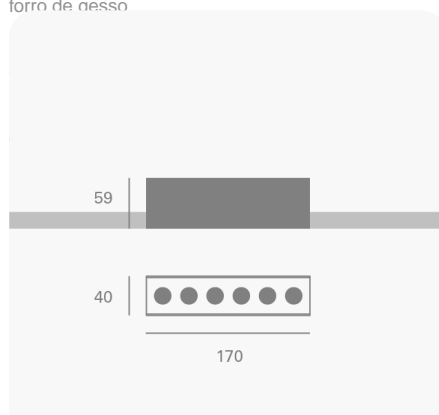

acabamentos e cores

cores

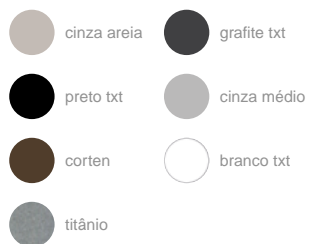

vista inferior

dimensões em milímetros

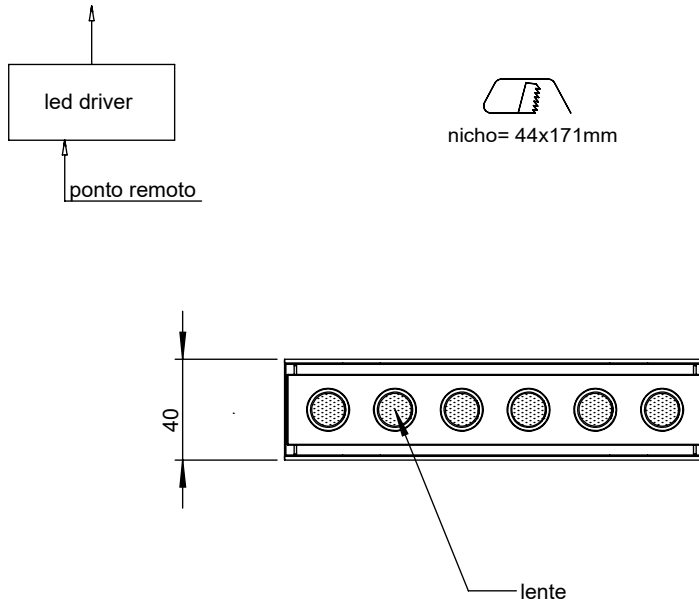

no frame concentra
flex 17 série 3

folha
1/1

escala
1:3

data

08/04/2025

desenhista

joão v.

aprovação

ronaldo

revisões

08/04/2025

vista lateral

dimensões em milímetros

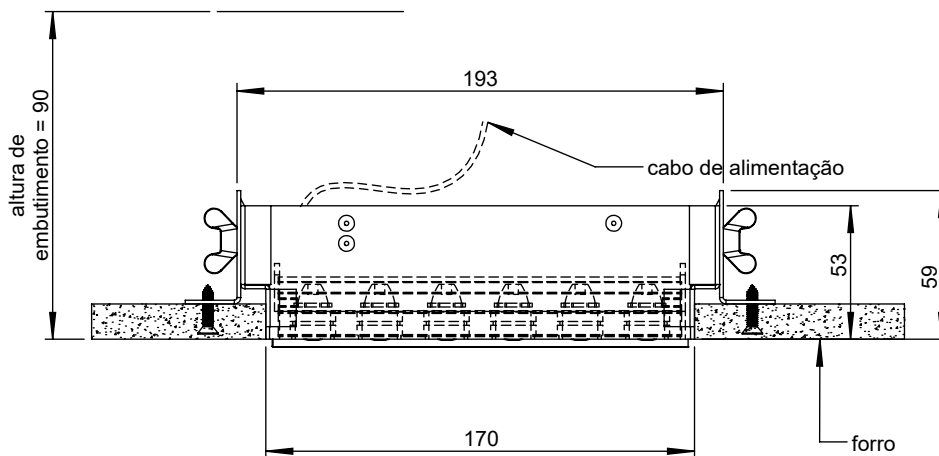

para maiores informações,
consulte a área técnica
produto@lumini.com.br

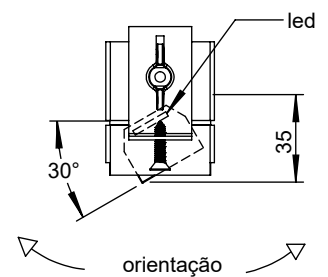



lumini Solucoes em Iluminacao LTDA
www.lumini.com.br
Email:laboratorio@lumini.com.br
Tel:+55 11 3437-5555 Fax:+55 11 3437-5555
Address:Rua Ferreira Viana, 716 - Socorro - São Paulo/SP

lumini

LumCAT:

Luminaire: no frame concentra flex 17 serie 3 e fc

LampCAT: modulo led 6W 30K irc 90

Ballast type: led driver 700mA

Report No:

Voltage(V): 220.0000

Test No:

Current(A): 0.0360

Number of Lamps: 1

Power (W): 7.4000

Lamp flux(lm): 715.0

PF: 0.9700

Length(mm): 145

Width(mm): 20

Phm Type: C

Height(mm): 0

Photometric Results

Lumens(lm): 481.63, Efficiency(%): 67.36% , Luminous Efficacy(lm/W): 65.08

Central intensity(cd): 3418.017, Maximum intensity(cd): 3418.017

Angle of maximum intensity: $C=0.0$ $\gamma=0.0$

Beam angle of C0 plane : 17.70

Aveage BeamAngle(IEC 61341):17.70

Equipment: equipamento lumini
Temperature(°C): 25.5

Date: 8/5/2024
Humidity(%): 55.0%

Operator: 01
Distance(m): 6.90

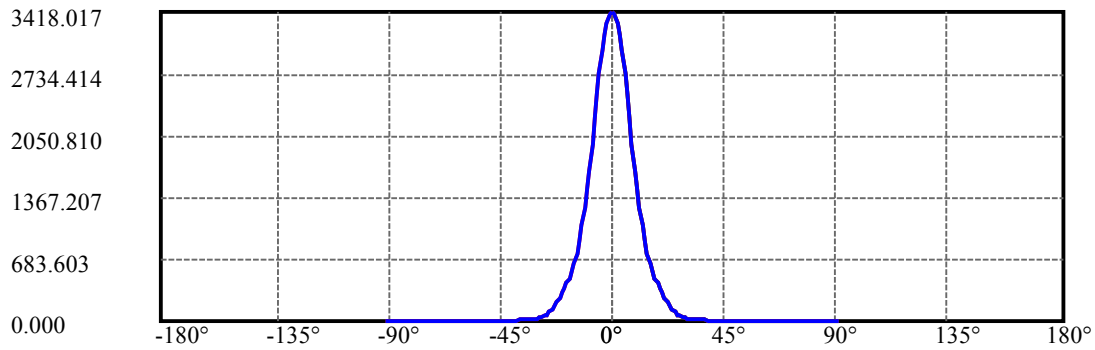
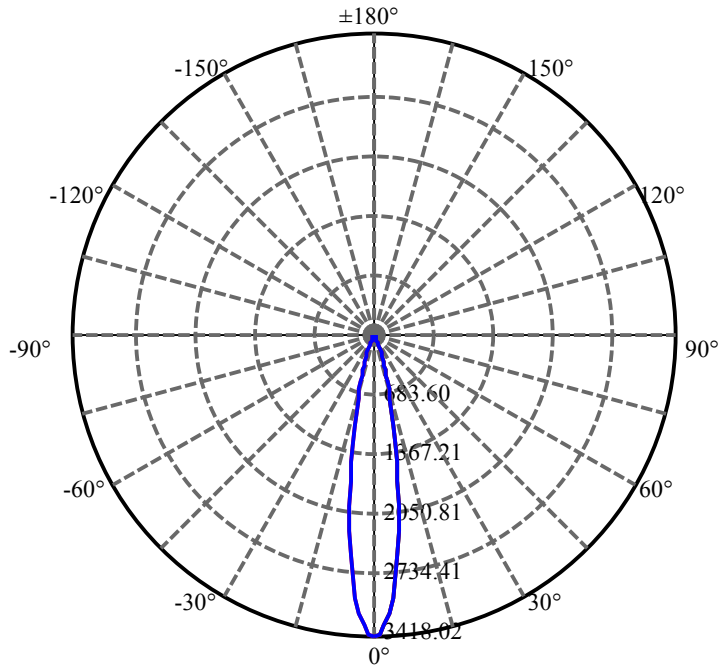

C0(Max): —
C0/C180: —
C90/C270: —

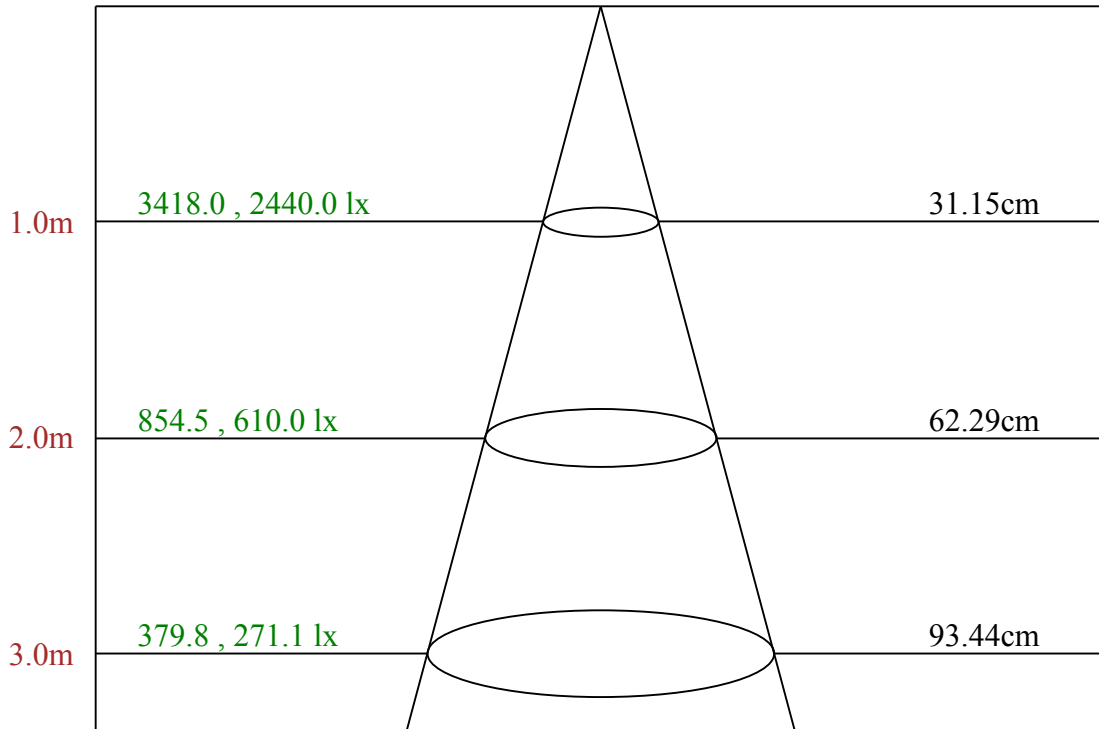

Max , Ave Beam angle of C0 plane 17.70

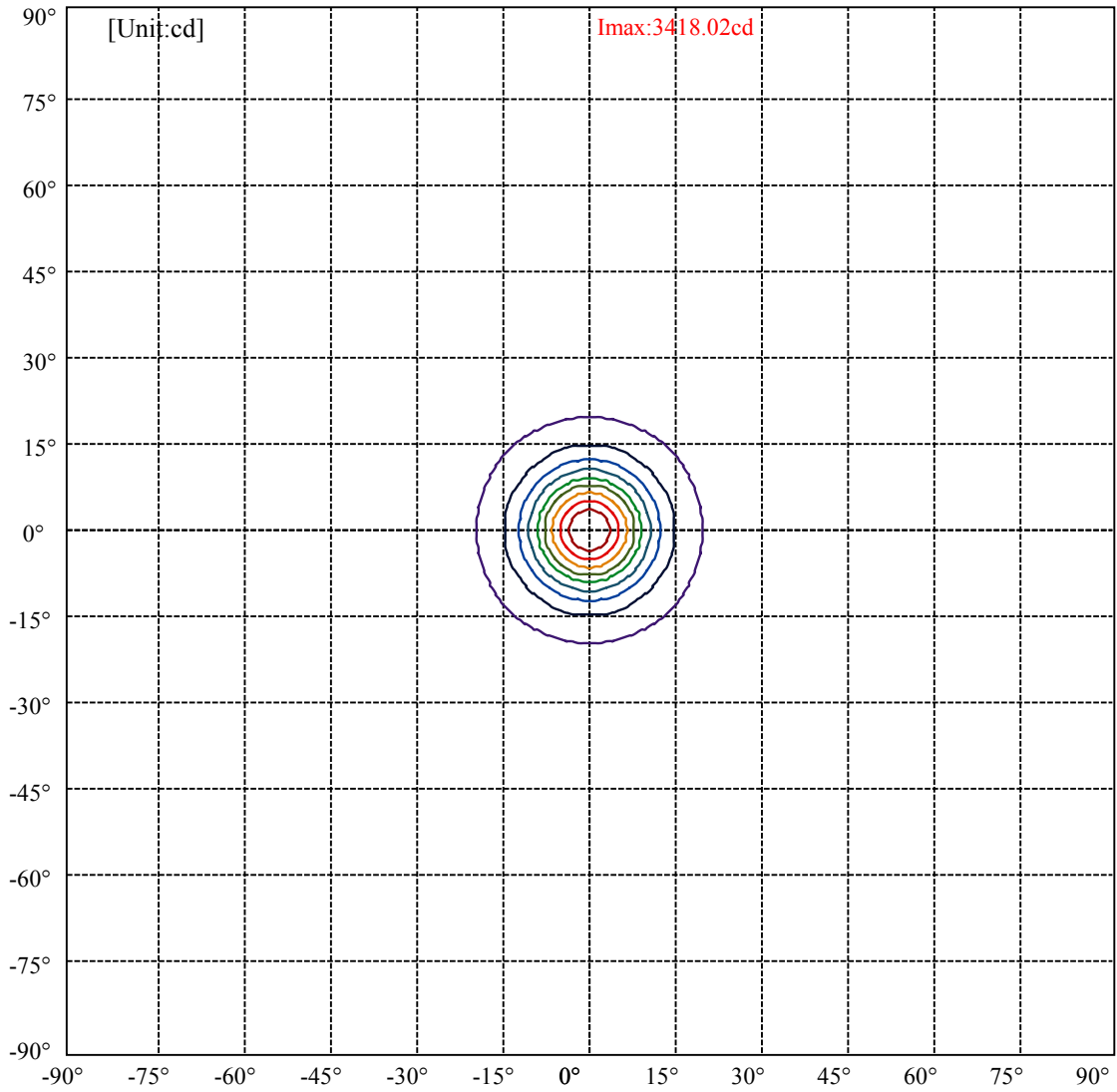

(10%Imax) 341.802	—
(20%Imax) 683.603	—
(30%Imax) 1025.41	—
(40%Imax) 1367.21	—
(50%Imax) 1709.01	—
(60%Imax) 2050.81	—
(70%Imax) 2392.61	—
(80%Imax) 2734.41	—
(90%Imax) 3076.22	—

lumini

Luminance Limiting Curve(no luminous side)

Luminance Table

γ	45	50	55	60	65	70	75	80	85
C0	2600	2056	1345	1248	1350	1608	1998	2978	5934
C45	2600	2056	1345	1248	1350	1608	1998	2978	5934
C90	2600	2056	1345	1248	1350	1608	1998	2978	5934

L(Hor)(65)	L(Ver)(65)	L45(65)	L(Hor)(75)	L(Ver)(75)	L45(75)	L(Hor)(85)	L(Ver)(85)	L45(85)
1350	1350	1350	1998	1998	1998	5934	5934	5934

Glare Table

Glare	Quality	Service Values Illuminance(lx)							
1.15	A	2000	1000	500	<=300				
1.5	B		2000	1000	500	<=300			
1.85	C			2000	1000	500	<=300		
2.2	D				2000	1000	500	<=300	
2.55	E					2000	1000	500	<=300
		a	b	c	d	e	f	g	h

Luminance Limiting Curve

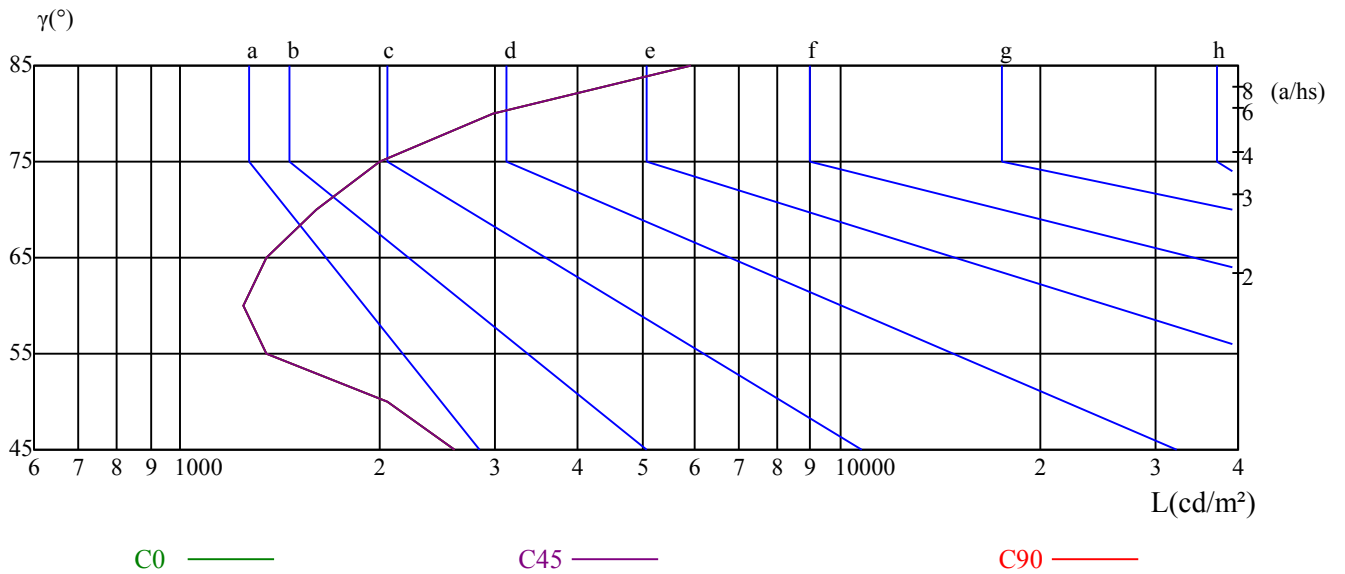

Illumination assessment according UGR											
Rf of Ceiling	70	70	50	50	30	70	70	50	50	30	
Rf of Wall	50	30	50	30	30	50	30	50	30	30	
Rf of Floor	20	20	20	20	20	20	20	20	20	20	
Room dimensions		Viewed crosswise					Viewed endwise				
X	Y										
2H	2H	4.45	5.36	4.81	5.67	5.99	4.74	5.65	5.10	5.96	6.28
	3H	5.57	6.39	5.96	6.72	7.07	5.77	6.59	6.16	6.92	7.27
	4H	6.48	7.23	6.88	7.58	7.95	6.62	7.37	7.02	7.72	8.09
	6H	7.80	8.49	8.22	8.87	9.27	7.88	8.56	8.30	8.94	9.34
	8H	8.61	9.26	9.03	9.65	10.06	8.70	9.35	9.12	9.74	10.15
	12H	9.64	10.26	10.07	10.65	11.07	9.68	10.30	10.11	10.70	11.12
4H	2H	4.63	5.38	5.03	5.74	6.10	4.89	5.64	5.29	5.99	6.36
	3H	6.11	6.74	6.54	7.14	7.55	6.26	6.89	6.68	7.28	7.70
	4H	7.34	7.88	7.78	8.31	8.75	7.43	7.97	7.87	8.40	8.85
	6H	8.93	9.41	9.41	9.87	10.32	8.97	9.45	9.45	9.90	10.36
	8H	9.92	10.36	10.41	10.82	11.30	9.98	10.43	10.47	10.89	11.36
	12H	11.15	11.56	11.64	12.01	12.53	11.17	11.58	11.66	12.03	12.55
8H	4H	7.82	8.27	8.31	8.73	9.20	7.90	8.34	8.39	8.80	9.28
	6H	9.75	10.11	10.26	10.59	11.11	9.78	10.14	10.29	10.62	11.13
	8H	11.00	11.30	11.53	11.82	12.32	11.05	11.35	11.58	11.87	12.37
	12H	12.48	12.71	13.02	13.22	13.75	12.49	12.71	13.03	13.23	13.76
12H	4H	7.98	8.39	8.47	8.84	9.37	8.06	8.46	8.55	8.92	9.44
	6H	10.08	10.38	10.62	10.91	11.41	10.11	10.41	10.64	10.93	11.43
	8H	11.42	11.65	11.96	12.16	12.69	11.46	11.69	12.01	12.21	12.73
Variation with the observer position at spacings:											
S = 1.0H		1.4/-1.2					1.4/-1.2				
S = 1.5H		1.6/-1.3					1.6/-1.3				
S = 2.0H		1.8/-1.2					1.8/-1.2				
Standard tables:		BKBF					BKBF				
Uncorrected UGR		-5.9					-5.9				

依据CIE Publ. 117 计算 UGR, S/H = 0.25



lumini Solucoes em Iluminacao LTDA
www.lumini.com.br
Email:laboratorio@lumini.com.br
Tel:+55 11 3437-5555 Fax:+55 11 3437-5555
Address:Rua Ferreira Viana, 716 - Socorro - São Paulo/SP

lumini

LumCAT:

Luminaire: no frame concentra flex 17 serie 3 e fm

LampCAT: modulo led 6W 30K irc 90

Ballast type: led driver 700mA

Report No:

Voltage(V): 220.0000

Test No:

Current(A): 0.0360

Number of Lamps: 1

Power (W): 7.3900

Lamp flux(lm): 715.0

PF: 0.9700

Length(mm): 145

Width(mm): 20

Phm Type: C

Height(mm): 0

Photometric Results

Lumens(lm): 553.75, Efficiency(%): 77.45% , Luminous Efficacy(lm/W): 74.93

Central intensity(cd): 2276.567, Maximum intensity(cd): 2276.567

Angle of maximum intensity: $C=0.0$ $\gamma=0.0$

Beam angle of C0 plane : 28.00

Aveage BeamAngle(IEC 61341):28.00

Equipment: equipamento lumini
Temperature(°C): 25.5

Date: 8/5/2024
Humidity(%): 55.0%

Operator: 01
Distance(m): 6.90

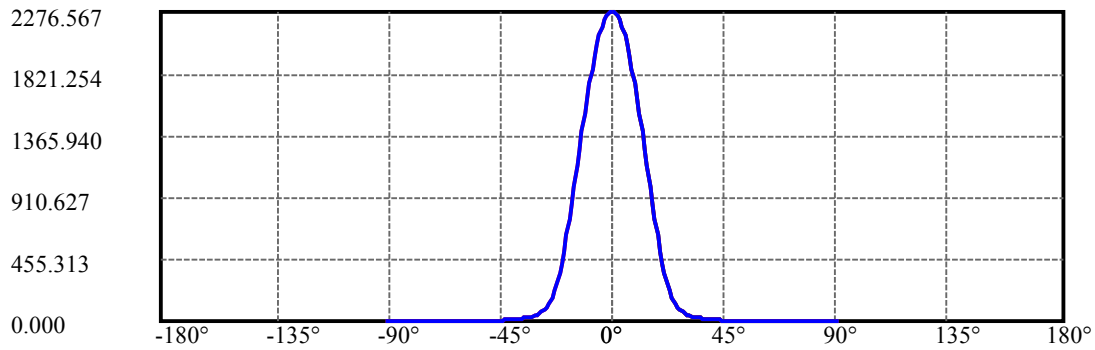
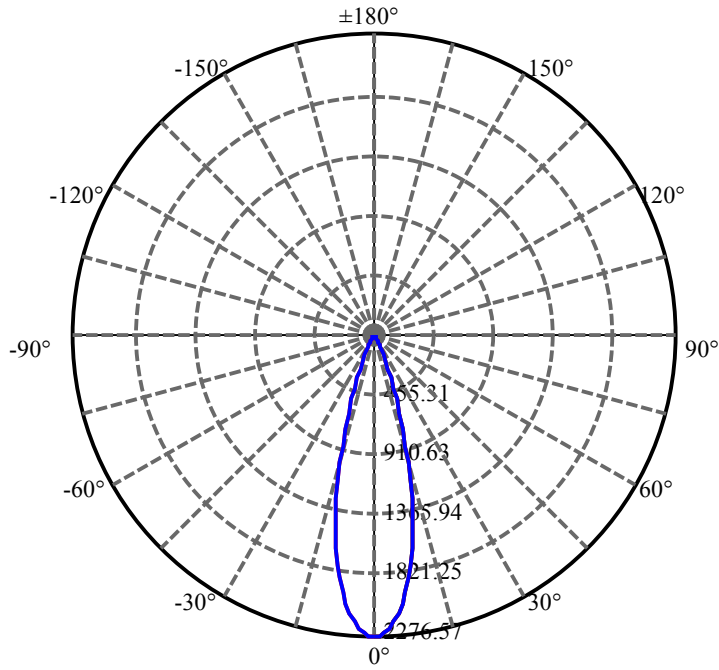

C0(Max): —————
C0/C180: —————
C90/C270: —————

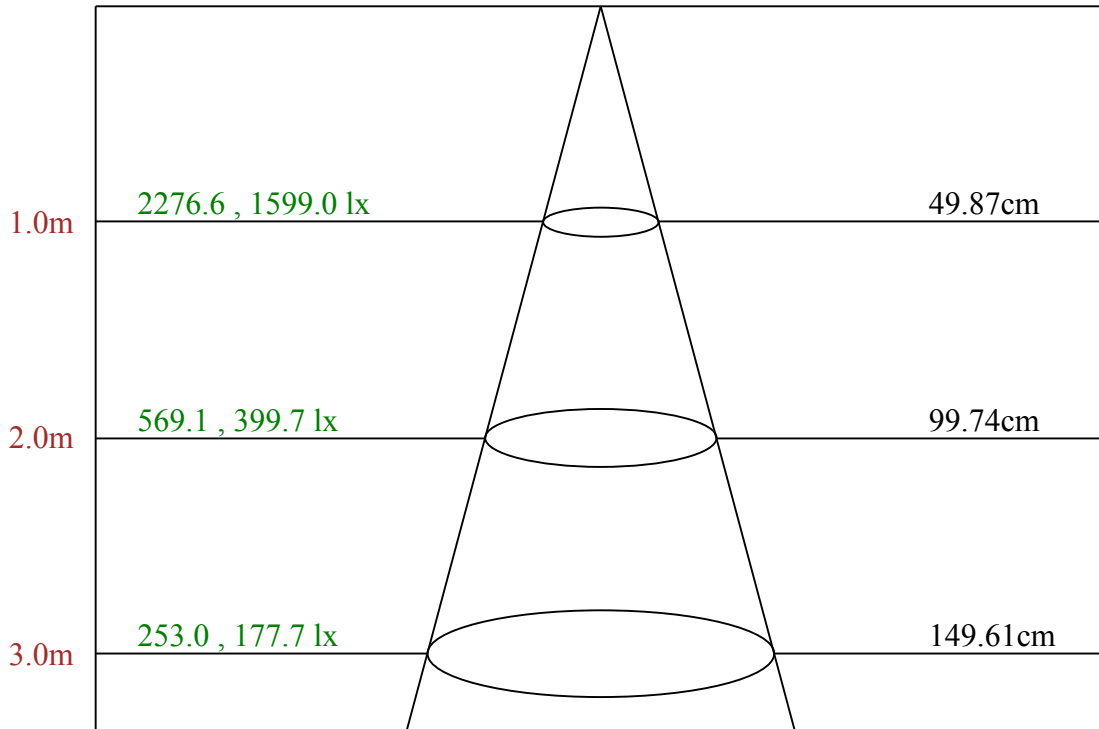

Max , Ave Beam angle of C0 plane 28.00

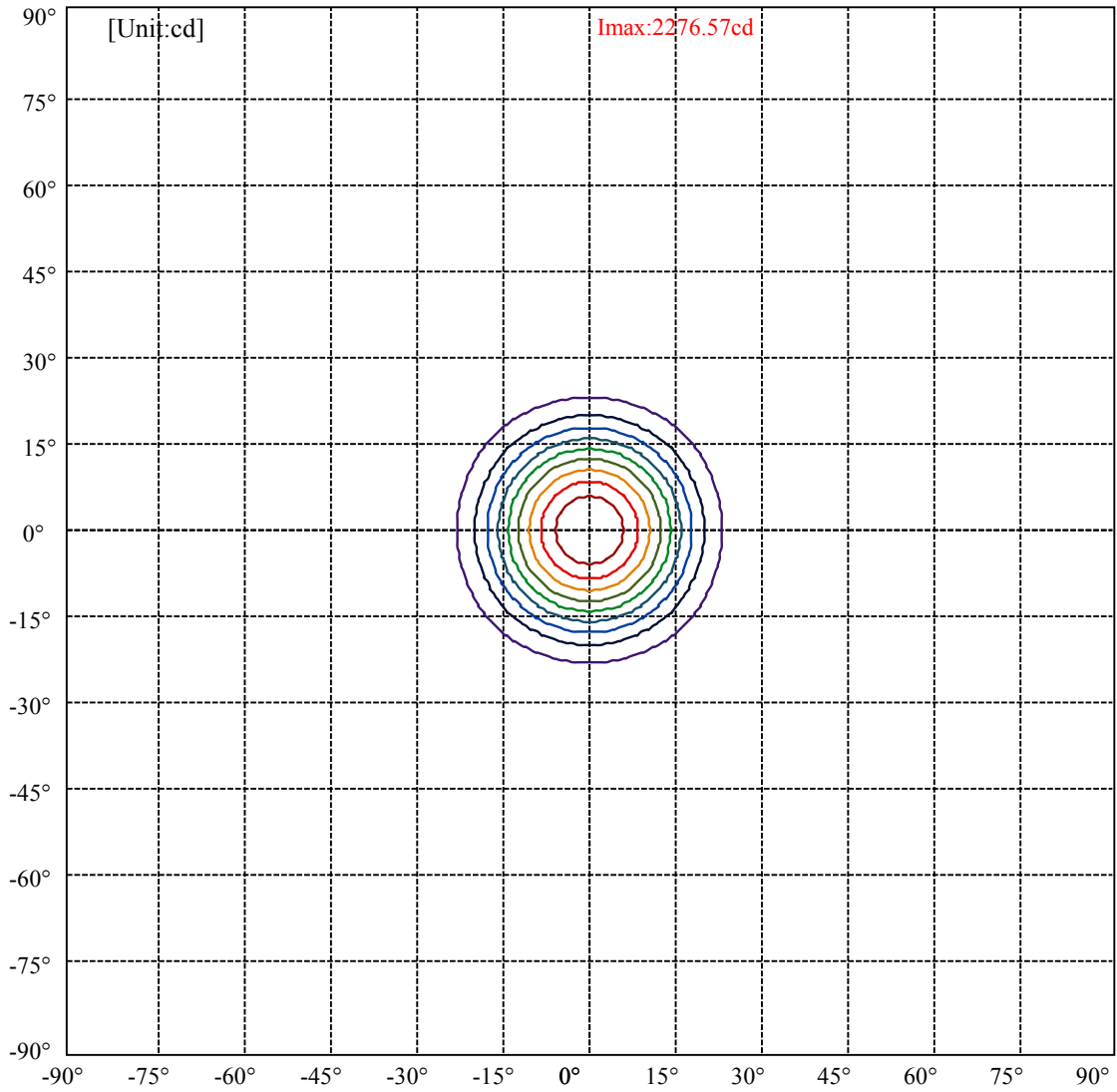

(10%Imax) 227.657	—
(20%Imax) 455.313	—
(30%Imax) 682.97	—
(40%Imax) 910.627	—
(50%Imax) 1138.28	—
(60%Imax) 1365.94	—
(70%Imax) 1593.6	—
(80%Imax) 1821.25	—
(90%Imax) 2048.91	—

lumini

Luminance Limiting Curve(no luminous side)

Luminance Table

γ	45	50	55	60	65	70	75	80	85
C0	2931	1947	1388	1330	1476	1728	2236	3333	6687
C45	2931	1947	1388	1330	1476	1728	2236	3333	6687
C90	2931	1947	1388	1330	1476	1728	2236	3333	6687

L(Hor)(65)	L(Ver)(65)	L45(65)	L(Hor)(75)	L(Ver)(75)	L45(75)	L(Hor)(85)	L(Ver)(85)	L45(85)
1476	1476	1476	2236	2236	2236	6687	6687	6687

Glare Table

Glare	Quality	Service Values Illuminance(lx)							
1.15	A	2000	1000	500	<=300				
1.5	B		2000	1000	500	<=300			
1.85	C			2000	1000	500	<=300		
2.2	D				2000	1000	500	<=300	
2.55	E					2000	1000	500	<=300
		a	b	c	d	e	f	g	h

Luminance Limiting Curve

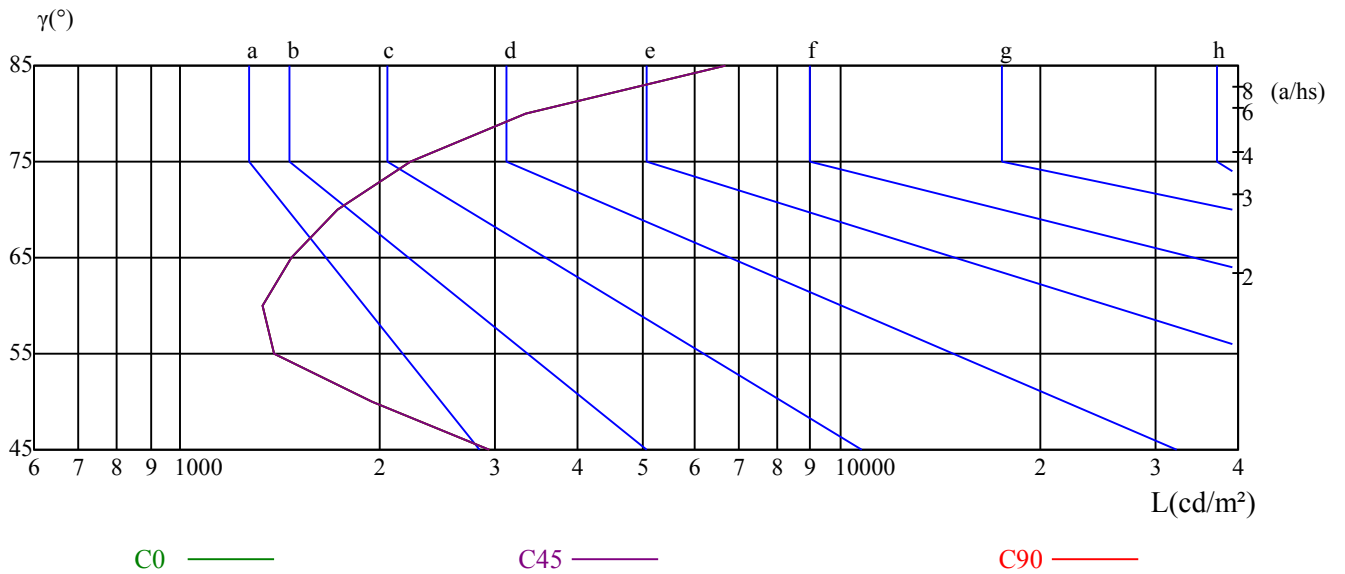

Illumination assessment according UGR											
Rf of Ceiling	70	70	50	50	30	70	70	50	50	30	
Rf of Wall	50	30	50	30	30	50	30	50	30	30	
Rf of Floor	20	20	20	20	20	20	20	20	20	20	
Room dimensions		Viewed crosswise					Viewed endwise				
X	Y										
2H	2H	5.73	6.64	6.09	6.95	7.26	6.08	6.99	6.45	7.31	7.62
	3H	6.52	7.33	6.91	7.67	8.02	6.81	7.62	7.19	7.95	8.30
	4H	7.26	8.01	7.67	8.37	8.74	7.49	8.24	7.90	8.60	8.97
	6H	8.45	9.13	8.87	9.51	9.91	8.60	9.28	9.02	9.66	10.06
	8H	9.23	9.88	9.66	10.27	10.68	9.35	10.00	9.77	10.39	10.80
	12H	10.20	10.82	10.63	11.22	11.64	10.29	10.91	10.72	11.30	11.72
4H	2H	5.76	6.51	6.16	6.86	7.23	6.08	6.83	6.48	7.19	7.55
	3H	6.87	7.50	7.30	7.90	8.32	7.11	7.74	7.54	8.14	8.55
	4H	7.95	8.49	8.39	8.92	9.37	8.12	8.67	8.56	9.09	9.54
	6H	9.44	9.92	9.92	10.37	10.83	9.53	10.01	10.01	10.47	10.92
	8H	10.43	10.87	10.92	11.33	11.81	10.51	10.95	10.99	11.41	11.88
	12H	11.62	12.03	12.11	12.48	13.01	11.67	12.08	12.17	12.54	13.06
8H	4H	8.37	8.81	8.86	9.27	9.75	8.51	8.96	9.00	9.42	9.89
	6H	10.20	10.56	10.70	11.04	11.55	10.26	10.62	10.77	11.10	11.62
	8H	11.46	11.76	11.99	12.28	12.78	11.51	11.81	12.05	12.33	12.83
	12H	12.91	13.14	13.46	13.66	14.18	12.94	13.17	13.49	13.69	14.21
12H	4H	8.51	8.92	9.00	9.37	9.90	8.65	9.06	9.14	9.51	10.03
	6H	10.51	10.81	11.05	11.34	11.84	10.57	10.87	11.11	11.40	11.89
	8H	11.86	12.09	12.41	12.61	13.13	11.91	12.13	12.45	12.65	13.18
Variation with the observer position at spacings:											
S = 1.0H		2.5/-1.7					2.5/-1.7				
S = 1.5H		3.0/-1.6					3.0/-1.6				
S = 2.0H		3.4/-1.5					3.4/-1.5				
Standard tables:		BKBF					BKBF				
Uncorrected UGR		-5.1					-5.1				

依据CIE Publ. 117 计算 UGR, S/H = 0.25



lumini Solucoes em Iluminacao LTDA
www.lumini.com.br
Email:laboratorio@lumini.com.br
Tel:+55 11 3437-5555 Fax:+55 11 3437-5555
Address:Rua Ferreira Viana, 716 - Socorro - São Paulo/SP

lumini

LumCAT:

Luminaire: no frame concentra flex 17 serie 3 e fa

LampCAT: modulo led 6W 30K irc 90

Ballast type: led driver 700mA

Report No:

Voltage(V): 221.0000

Test No:

Current(A): 0.0360

Number of Lamps: 1

Power (W): 7.3700

Lamp flux(lm): 715.0

PF: 0.9700

Length(mm): 145

Width(mm): 20

Phm Type: C

Height(mm): 0

Photometric Results

Lumens(lm): 477.19, Efficiency(%): 66.74% , Luminous Efficacy(lm/W): 64.75

Central intensity(cd): 799.705, Maximum intensity(cd): 799.705

Angle of maximum intensity: $C=0.0$ $\gamma=0.0$

Beam angle of C0 plane : 44.56

Aveage BeamAngle(IEC 61341):44.56

Equipment: equipamento lumini
Temperature(°C): 25.5

Date: 8/7/2024
Humidity(%): 55.0%

Operator: 01
Distance(m): 6.90

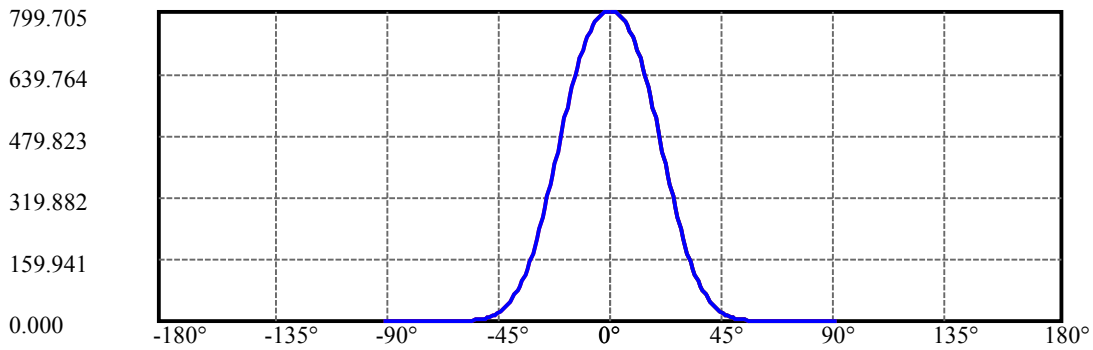
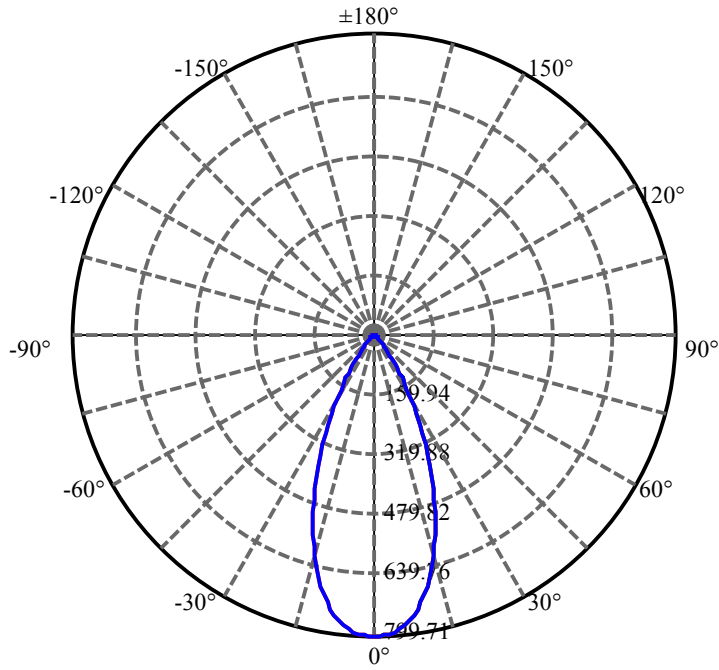

C0(Max): —
C0/C180: —
C90/C270: —

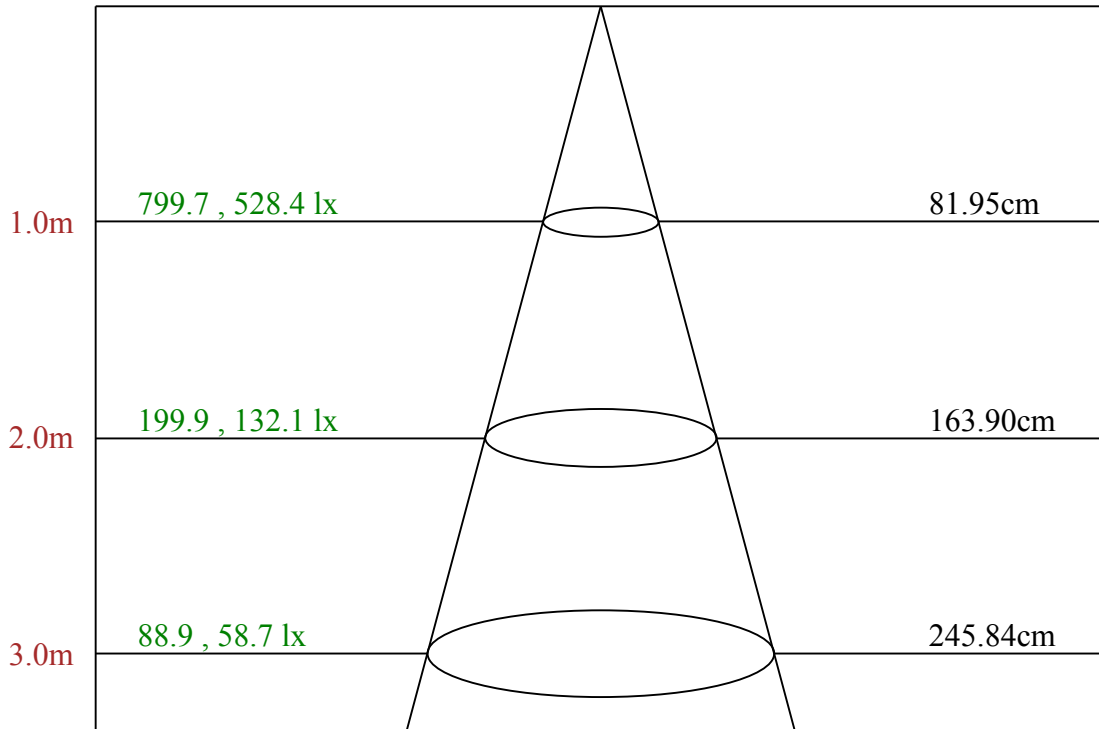

Max , Ave Beam angle of C0 plane 44.56

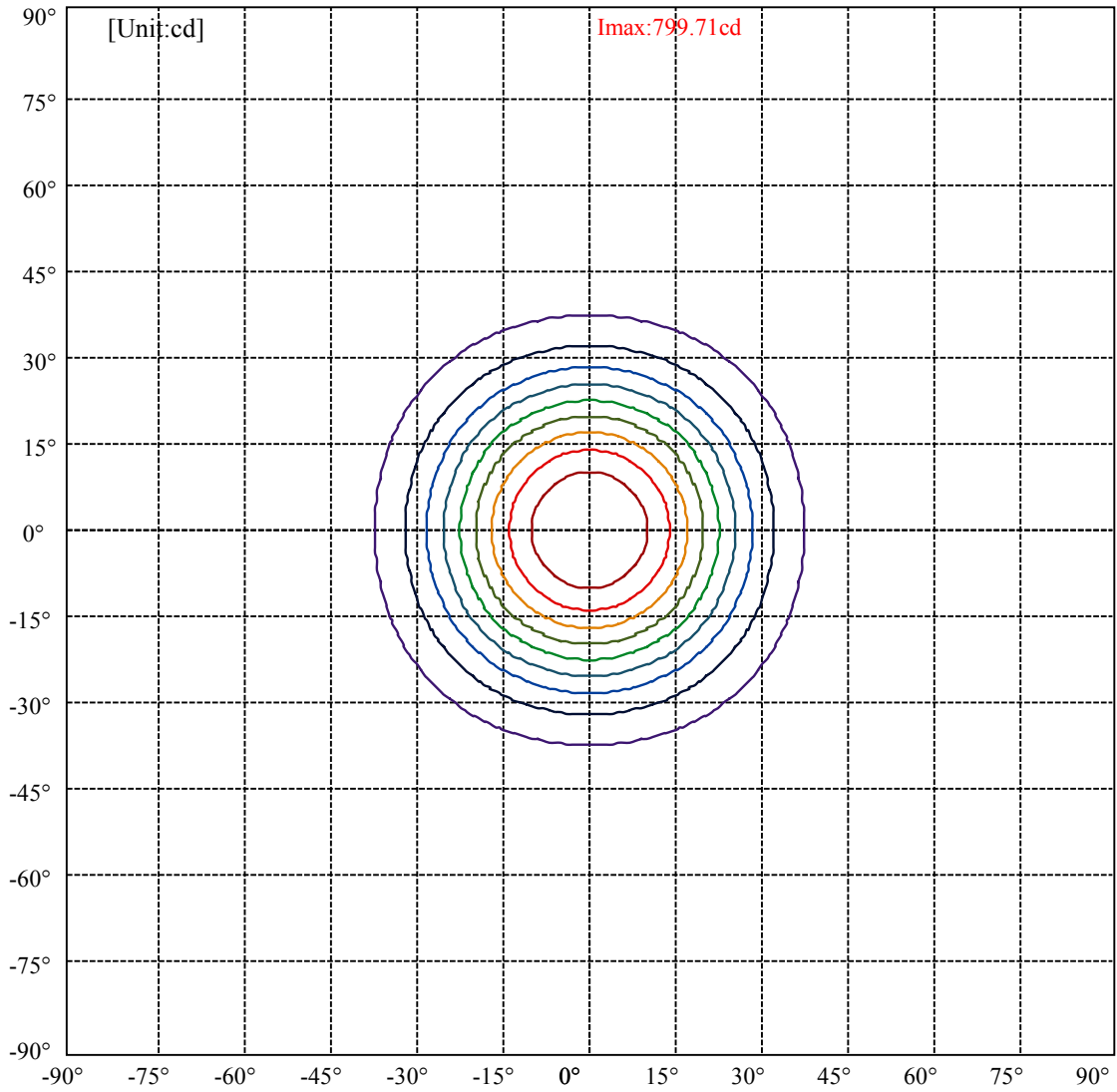

(10%Imax) 79.9705	—
(20%Imax) 159.941	—
(30%Imax) 239.912	—
(40%Imax) 319.882	—
(50%Imax) 399.853	—
(60%Imax) 479.823	—
(70%Imax) 559.794	—
(80%Imax) 639.764	—
(90%Imax) 719.735	—

lumini

Luminance Limiting Curve(no luminous side)

Luminance Table

γ	45	50	55	60	65	70	75	80	85
C0	9908	3742	1453	1133	1156	1320	1665	2387	4803
C45	9908	3742	1453	1133	1156	1320	1665	2387	4803
C90	9908	3742	1453	1133	1156	1320	1665	2387	4803

L(Hor)(65)	L(Ver)(65)	L45(65)	L(Hor)(75)	L(Ver)(75)	L45(75)	L(Hor)(85)	L(Ver)(85)	L45(85)
1156	1156	1156	1665	1665	1665	4803	4803	4803

Glare Table

Glare	Quality	Service Values Illuminance(lx)							
1.15	A	2000	1000	500	<=300				
1.5	B		2000	1000	500	<=300			
1.85	C			2000	1000	500	<=300		
2.2	D				2000	1000	500	<=300	
2.55	E					2000	1000	500	<=300
		a	b	c	d	e	f	g	h

Luminance Limiting Curve

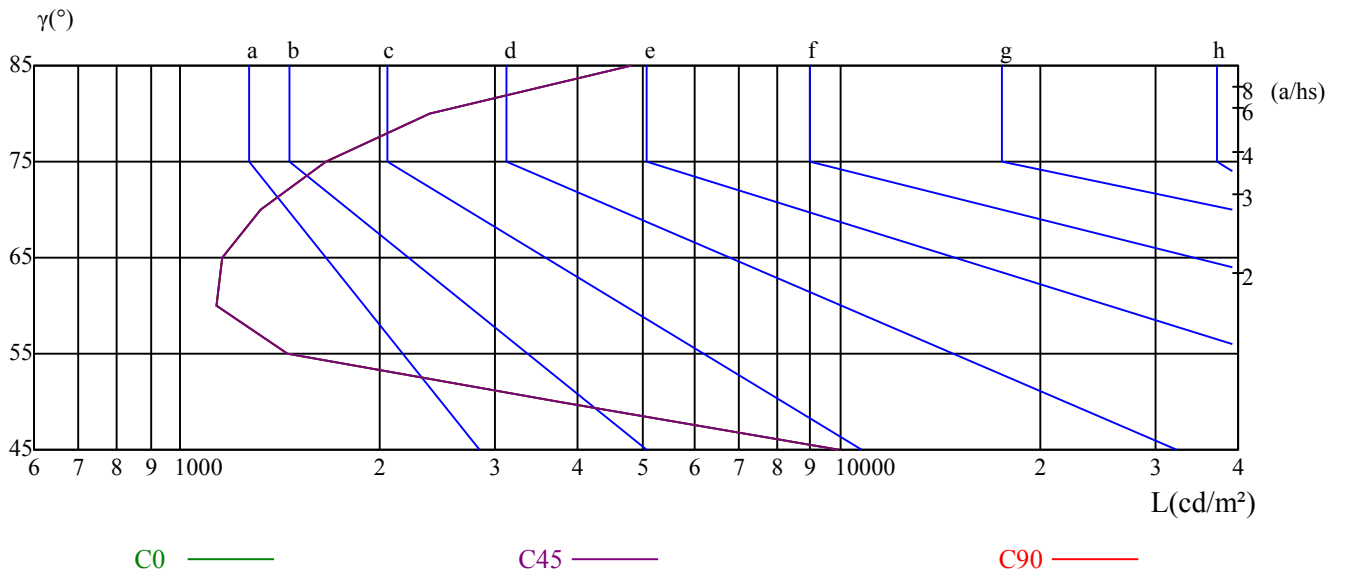

Illumination assessment according UGR											
Rf of Ceiling	70	70	50	50	30	70	70	50	50	30	
Rf of Wall	50	30	50	30	30	50	30	50	30	30	
Rf of Floor	20	20	20	20	20	20	20	20	20	20	
Room dimensions		Viewed crosswise					Viewed endwise				
X	Y										
2H	2H	15.48	16.43	15.84	16.74	17.06	16.09	17.04	16.45	17.35	17.67
	3H	15.31	16.15	15.70	16.49	16.83	15.92	16.76	16.31	17.10	17.45
	4H	15.24	16.02	15.64	16.37	16.74	15.86	16.63	16.26	16.99	17.36
	6H	15.23	15.94	15.64	16.31	16.71	15.85	16.56	16.26	16.93	17.33
	8H	15.22	15.90	15.64	16.28	16.69	15.84	16.52	16.26	16.90	17.31
	12H	15.26	15.90	15.68	16.29	16.71	15.88	16.52	16.31	16.92	17.34
4H	2H	15.18	15.96	15.58	16.31	16.68	15.78	16.56	16.19	16.92	17.28
	3H	14.99	15.64	15.42	16.04	16.45	15.60	16.25	16.02	16.64	17.06
	4H	14.98	15.54	15.42	15.97	16.42	15.59	16.15	16.03	16.57	17.02
	6H	14.98	15.47	15.45	15.92	16.38	15.59	16.08	16.06	16.54	16.99
	8H	15.05	15.50	15.53	15.96	16.44	15.66	16.11	16.14	16.57	17.05
	12H	15.19	15.61	15.68	16.07	16.59	15.81	16.23	16.30	16.69	17.21
8H	4H	14.83	15.29	15.32	15.75	16.22	15.43	15.89	15.91	16.34	16.82
	6H	14.89	15.26	15.40	15.74	16.26	15.49	15.86	15.99	16.34	16.85
	8H	15.09	15.40	15.62	15.93	16.42	15.68	15.99	16.21	16.51	17.01
	12H	15.37	15.61	15.91	16.13	16.65	15.97	16.21	16.51	16.73	17.25
12H	4H	14.80	15.22	15.29	15.67	16.19	15.39	15.81	15.88	16.26	16.79
	6H	14.93	15.24	15.46	15.77	16.26	15.52	15.83	16.05	16.35	16.85
	8H	15.14	15.38	15.68	15.90	16.42	15.71	15.95	16.25	16.47	16.99
Variation with the observer position at spacings:											
S = 1.0H	5.0/-9.9					5.0/-9.9					
S = 1.5H	7.5/-8.1					7.5/-8.1					
S = 2.0H	9.3/-6.8					9.3/-6.8					
Standard tables:	BK1					BK1					
Uncorrected UGR	-2.7					-2.7					

依据CIE Publ. 117 计算 UGR, S/H = 0.25



lumini Solucoes em Iluminacao LTDA
www.lumini.com.br
Email:laboratorio@lumini.com.br
Tel:+55 11 3437-5555 Fax:+55 11 3437-5555
Address:Rua Ferreira Viana, 716 - Socorro - São Paulo/SP

lumini

LumCAT:

Luminaire: no frame concentra flex 17 serie 3 e fc

LampCAT: modulo led 12W 30K irc 90

Ballast type: led driver 700mA

Report No:

Voltage(V): 220.0000

Test No:

Current(A): 0.0650

Number of Lamps: 1

Power (W): 14.0200

Lamp flux(lm): 1290.0

PF: 0.9700

Length(mm): 145

Width(mm): 20

Phm Type: C

Height(mm): 0

Photometric Results

Lumens(lm): 824.30, Efficiency(%): 63.90% , Luminous Efficacy(lm/W): 58.79

Central intensity(cd): 5893.452, Maximum intensity(cd): 5893.452

Angle of maximum intensity: $C=0.0$ $\gamma=0.0$

Beam angle of C0 plane : 17.88

Aveage BeamAngle(IEC 61341):17.88

Equipment: equipamento lumini
Temperature(°C): 25.5

Date: 8/5/2024
Humidity(%): 55.0%

Operator: 01
Distance(m): 6.90

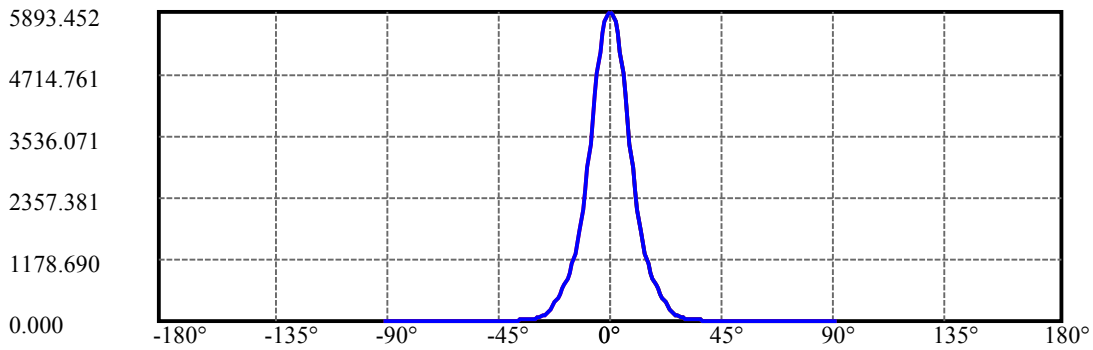
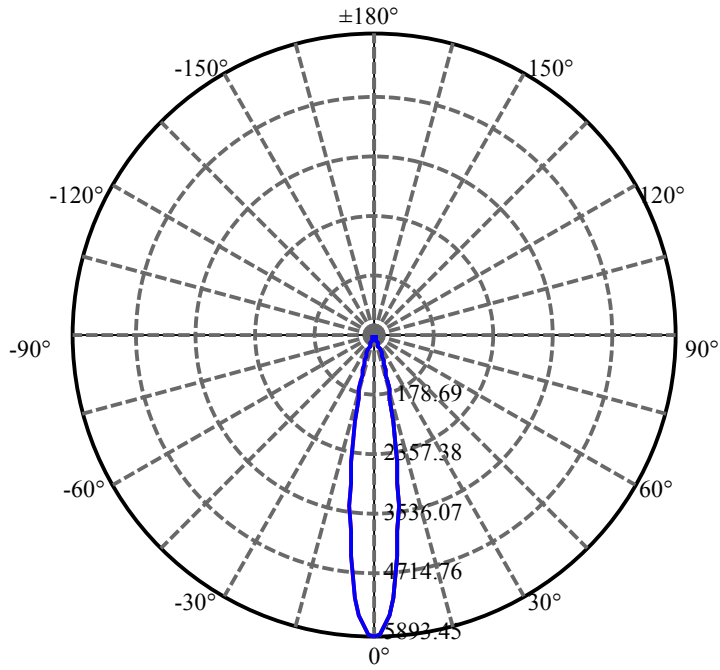

C0(Max): —————
C0/C180: —————
C90/C270: —————

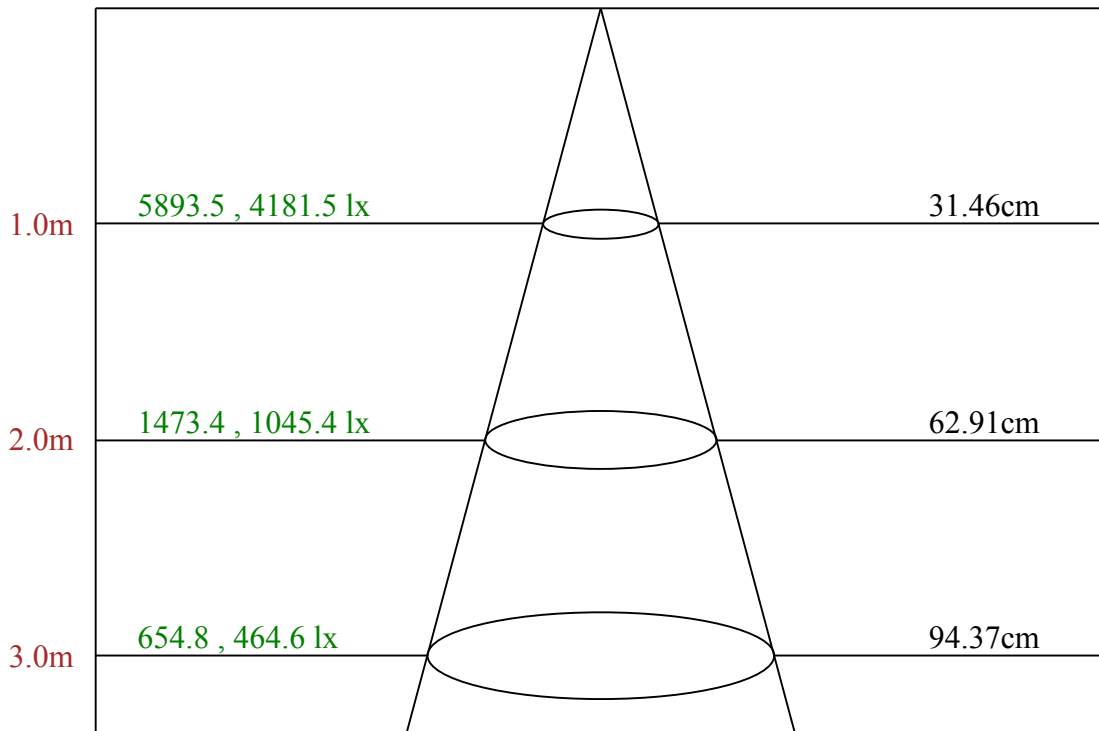

Max , Ave Beam angle of C0 plane 17.88

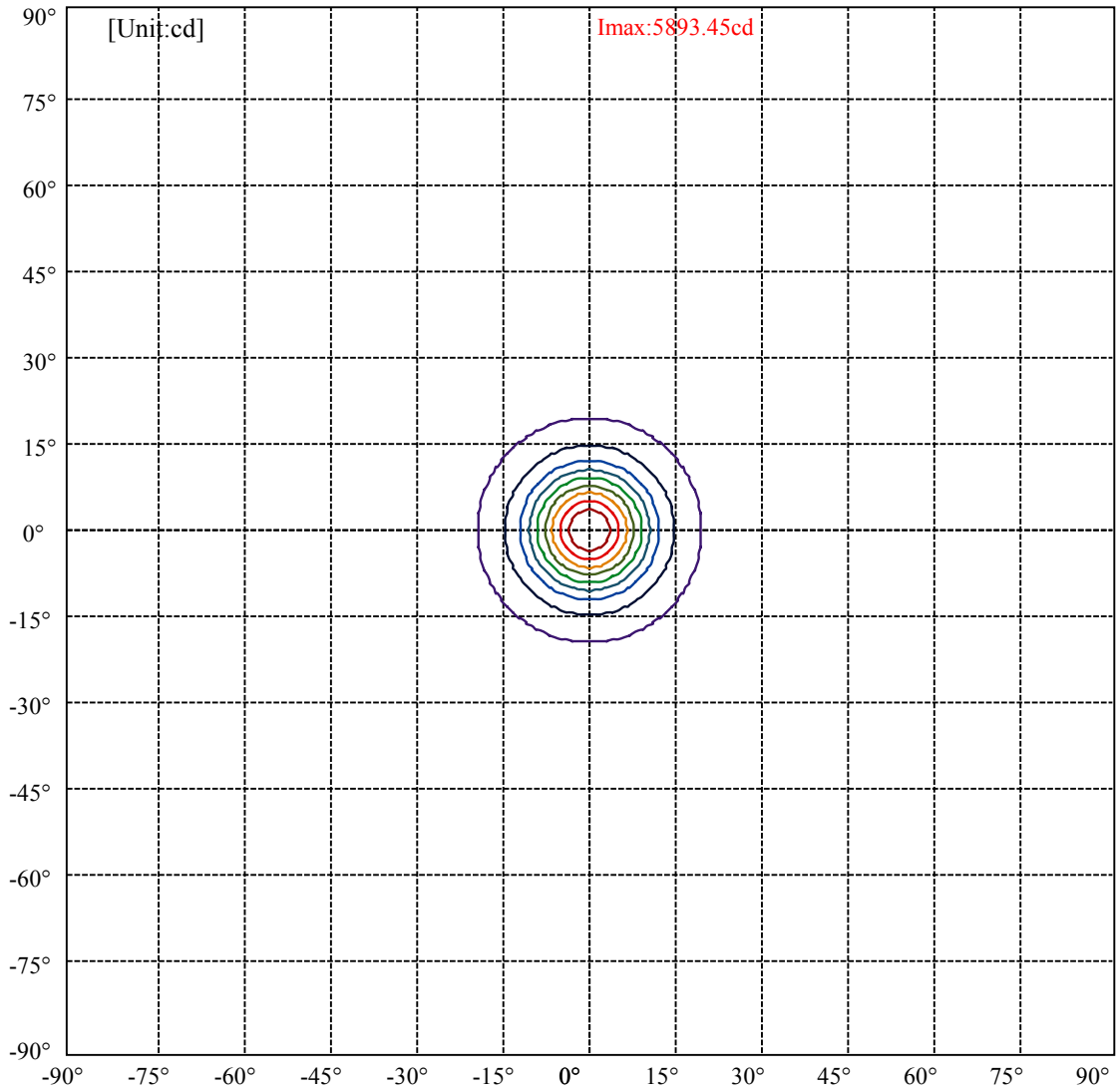

(10%Imax) 589.345	—
(20%Imax) 1178.69	—
(30%Imax) 1768.04	—
(40%Imax) 2357.38	—
(50%Imax) 2946.73	—
(60%Imax) 3536.07	—
(70%Imax) 4125.42	—
(80%Imax) 4714.76	—
(90%Imax) 5304.11	—

lumini

Luminance Limiting Curve(no luminous side)

Luminance Table

γ	45	50	55	60	65	70	75	80	85
C0	4376	3435	2233	2052	2234	2568	3330	4893	9654
C45	4376	3435	2233	2052	2234	2568	3330	4893	9654
C90	4376	3435	2233	2052	2234	2568	3330	4893	9654

L(Hor)(65)	L(Ver)(65)	L45(65)	L(Hor)(75)	L(Ver)(75)	L45(75)	L(Hor)(85)	L(Ver)(85)	L45(85)
2234	2234	2234	3330	3330	3330	9654	9654	9654

Glare Table

Glare	Quality	Service Values Illuminance(lx)							
1.15	A	2000	1000	500	<=300				
1.5	B		2000	1000	500	<=300			
1.85	C			2000	1000	500	<=300		
2.2	D				2000	1000	500	<=300	
2.55	E					2000	1000	500	<=300
		a	b	c	d	e	f	g	h

Luminance Limiting Curve

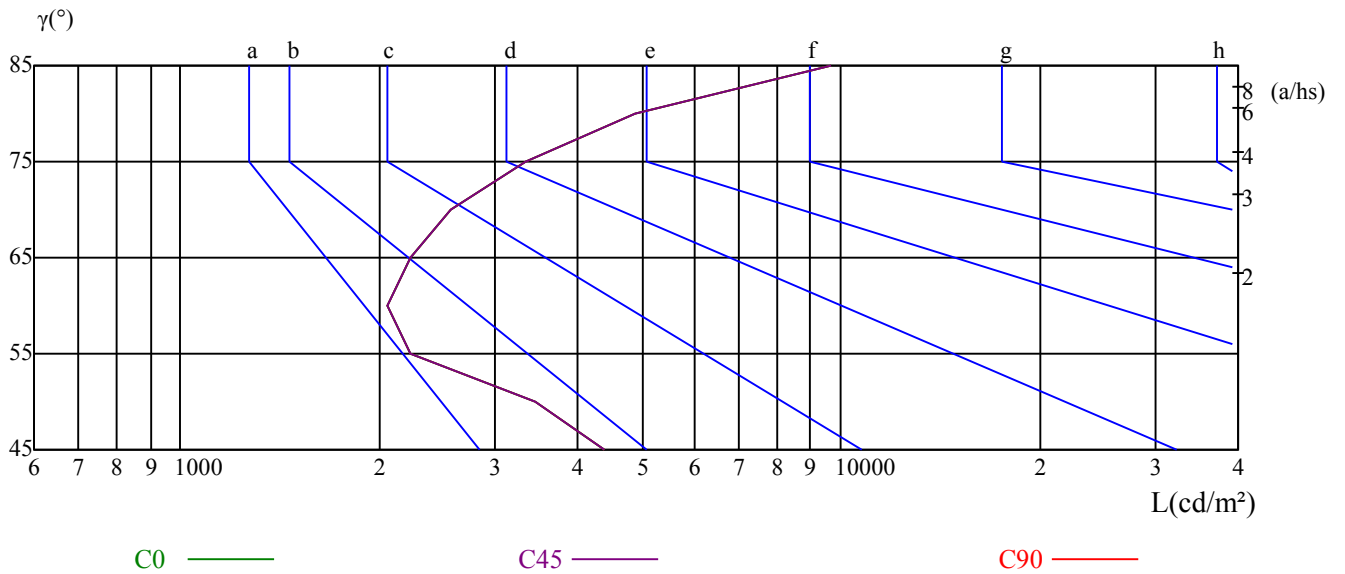

Illumination assessment according UGR											
Rf of Ceiling	70	70	50	50	30	70	70	50	50	30	
Rf of Wall	50	30	50	30	30	50	30	50	30	30	
Rf of Floor	20	20	20	20	20	20	20	20	20	20	
Room dimensions		Viewed crosswise					Viewed endwise				
X	Y										
2H	2H	6.23	7.14	6.60	7.46	7.77	6.44	7.35	6.80	7.66	7.98
	3H	7.31	8.12	7.70	8.46	8.80	7.43	8.24	7.82	8.58	8.93
	4H	8.18	8.93	8.59	9.29	9.66	8.28	9.03	8.68	9.38	9.75
	6H	9.48	10.17	9.90	10.54	10.94	9.51	10.19	9.93	10.57	10.97
	8H	10.30	10.96	10.73	11.34	11.75	10.31	10.96	10.74	11.35	11.76
	12H	11.33	11.94	11.76	12.34	12.76	11.32	11.93	11.75	12.33	12.75
4H	2H	6.38	7.13	6.78	7.48	7.85	6.56	7.31	6.96	7.67	8.03
	3H	7.79	8.42	8.22	8.81	9.23	7.88	8.51	8.31	8.91	9.32
	4H	8.99	9.53	9.43	9.96	10.41	9.06	9.60	9.50	10.02	10.47
	6H	10.57	11.04	11.04	11.50	11.95	10.57	11.05	11.04	11.50	11.95
	8H	11.58	12.03	12.07	12.49	12.96	11.57	12.01	12.06	12.47	12.95
8H	12H	12.81	13.22	13.30	13.67	14.19	12.78	13.19	13.28	13.65	14.17
	4H	9.44	9.89	9.93	10.35	10.82	9.50	9.94	9.99	10.40	10.88
	6H	11.35	11.71	11.86	12.19	12.71	11.35	11.71	11.86	12.19	12.70
	8H	12.64	12.94	13.18	13.47	13.97	12.62	12.92	13.16	13.45	13.95
12H	12H	14.12	14.35	14.67	14.87	15.39	14.10	14.32	14.64	14.84	15.36
	4H	9.60	10.00	10.09	10.46	10.98	9.65	10.06	10.14	10.51	11.03
	6H	11.68	11.98	12.22	12.51	13.00	11.68	11.98	12.22	12.50	13.00
8H	13.06	13.29	13.61	13.81	14.33	13.04	13.27	13.59	13.79	14.31	
Variation with the observer position at spacings:											
S = 1.0H		1.5/-1.2					1.5/-1.2				
S = 1.5H		1.7/-1.3					1.7/-1.3				
S = 2.0H		1.9/-1.3					1.9/-1.3				
Standard tables:		BKBF					BKBF				
Uncorrected UGR		-4.3					-4.3				

依据CIE Publ. 117 计算 UGR, S/H = 0.25



lumini Solucoes em Iluminacao LTDA
www.lumini.com.br
Email:laboratorio@lumini.com.br
Tel:+55 11 3437-5555 Fax:+55 11 3437-5555
Address:Rua Ferreira Viana, 716 - Socorro - São Paulo/SP

lumini

LumCAT:

Luminaire: no frame concentra flex 17 serie 3 e fm

LampCAT: modulo led 12W 30K irc 90

Ballast type: led driver 700mA

Report No:

Voltage(V): 220.0000

Test No:

Current(A): 0.0640

Number of Lamps: 1

Power (W): 13.9900

Lamp flux(lm): 1290.0

PF: 0.9700

Length(mm): 145

Width(mm): 20

Phm Type: C

Height(mm): 0

Photometric Results

Lumens(lm): 950.81, Efficiency(%): 73.71% , Luminous Efficacy(lm/W): 67.96

Central intensity(cd): 3946.013, Maximum intensity(cd): 3946.013

Angle of maximum intensity: $C=0.0$ $\gamma=0.0$

Beam angle of C0 plane : 27.69

Aveage BeamAngle(IEC 61341):27.69

Equipment: equipamento lumini
Temperature(°C): 25.5

Date: 8/5/2024
Humidity(%): 55.0%

Operator: 01
Distance(m): 6.90

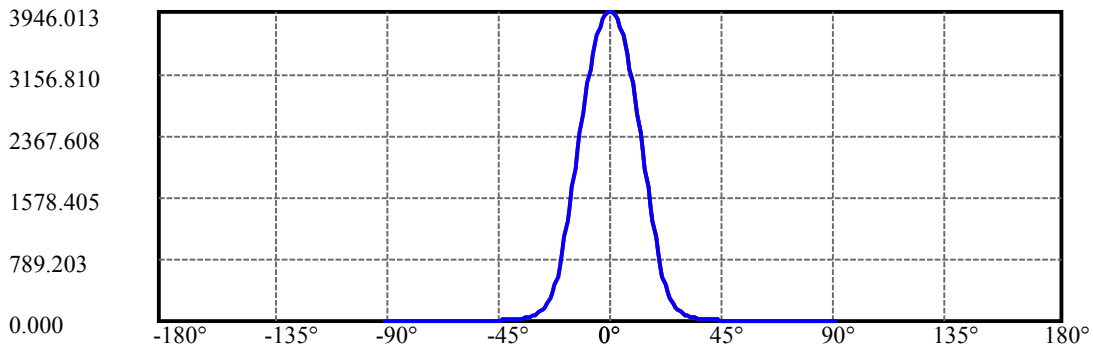
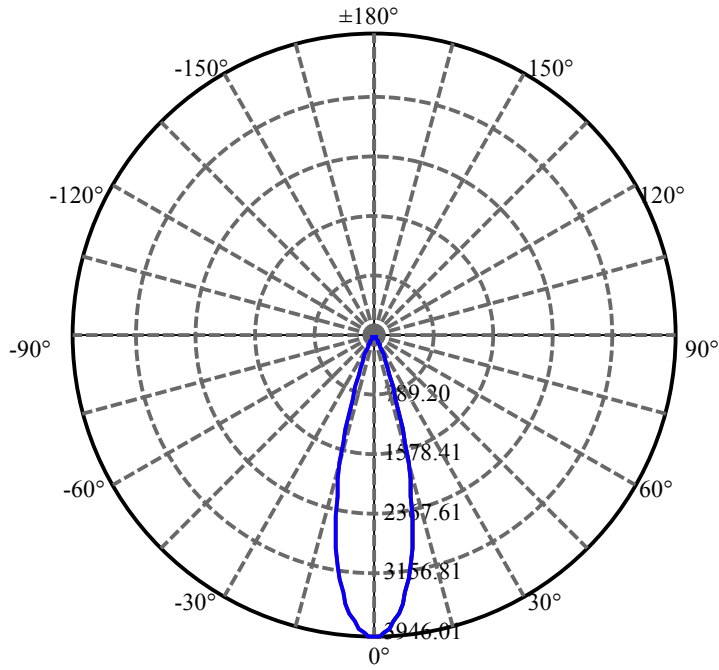

C0(Max): —————
C0/C180: —————
C90/C270: —————

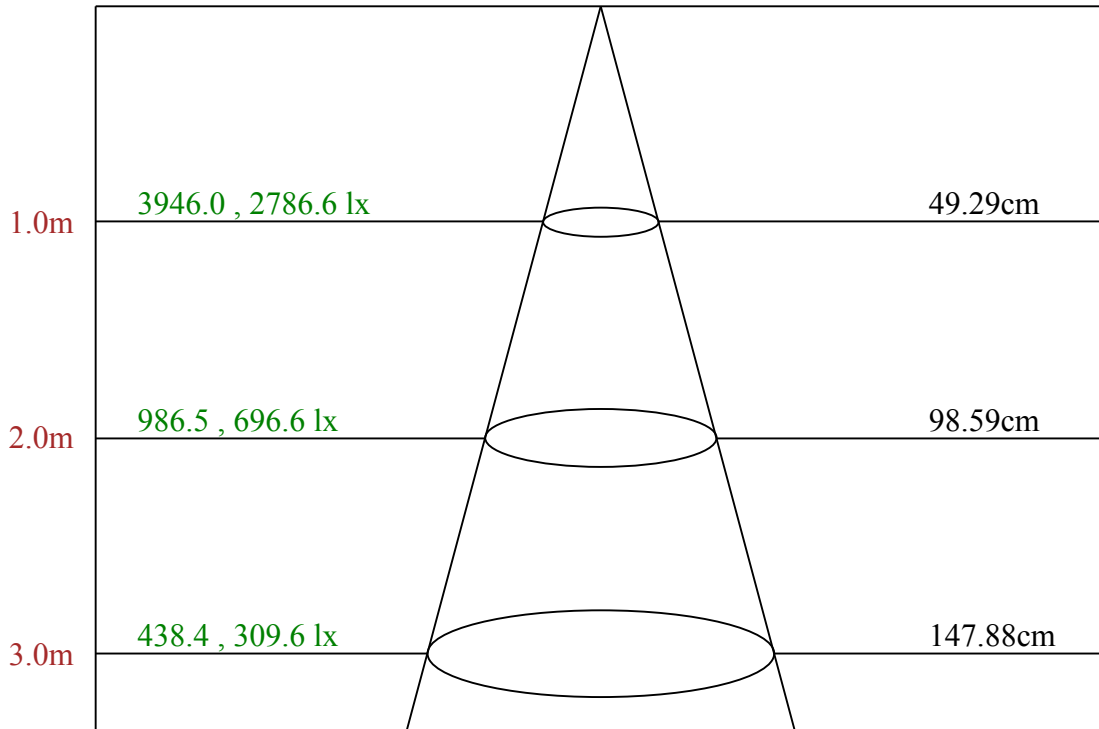

Max , Ave Beam angle of C0 plane 27.69

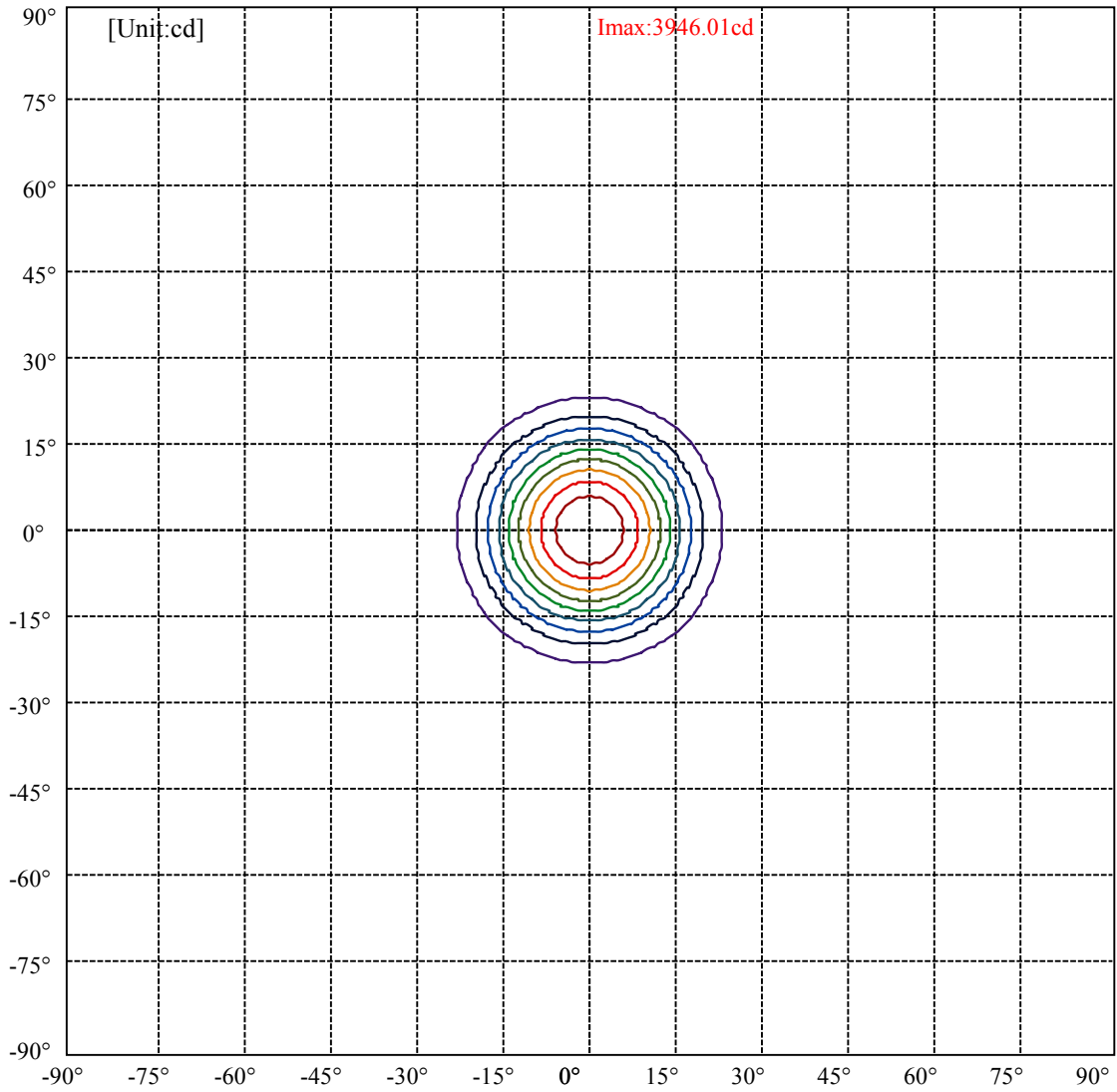

(10%Imax) 394.601	—
(20%Imax) 789.203	—
(30%Imax) 1183.8	—
(40%Imax) 1578.41	—
(50%Imax) 1973.01	—
(60%Imax) 2367.61	—
(70%Imax) 2762.21	—
(80%Imax) 3156.81	—
(90%Imax) 3551.41	—

lumini

Luminance Limiting Curve(no luminous side)

Luminance Table

γ	45	50	55	60	65	70	75	80	85
C0	4969	3365	2369	2282	2506	2964	3838	5720	11537
C45	4969	3365	2369	2282	2506	2964	3838	5720	11537
C90	4969	3365	2369	2282	2506	2964	3838	5720	11537

L(Hor)(65)	L(Ver)(65)	L45(65)	L(Hor)(75)	L(Ver)(75)	L45(75)	L(Hor)(85)	L(Ver)(85)	L45(85)
2506	2506	2506	3838	3838	3838	11537	11537	11537

Glare Table

Glare	Quality	Service Values Illuminance(lx)							
1.15	A	2000	1000	500	<=300				
1.5	B		2000	1000	500	<=300			
1.85	C			2000	1000	500	<=300		
2.2	D				2000	1000	500	<=300	
2.55	E					2000	1000	500	<=300
		a	b	c	d	e	f	g	h

Luminance Limiting Curve

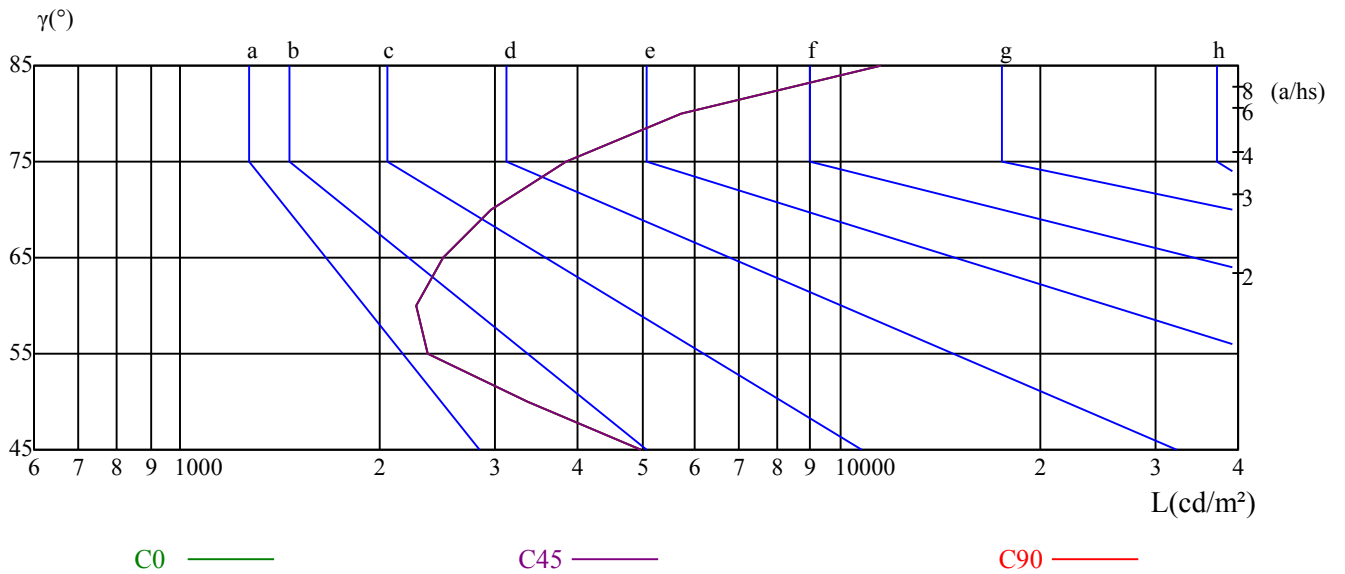

Illumination assessment according UGR											
Rf of Ceiling	70	70	50	50	30	70	70	50	50	30	
Rf of Wall	50	30	50	30	30	50	30	50	30	30	
Rf of Floor	20	20	20	20	20	20	20	20	20	20	
Room dimensions		Viewed crosswise					Viewed endwise				
X	Y										
2H	2H	7.60	8.51	7.96	8.82	9.14	7.91	8.82	8.27	9.13	9.44
	3H	8.43	9.24	8.82	9.58	9.92	8.61	9.42	8.99	9.75	10.10
	4H	9.21	9.96	9.61	10.31	10.68	9.27	10.02	9.67	10.38	10.74
	6H	10.44	11.12	10.86	11.50	11.90	10.37	11.05	10.78	11.43	11.83
	8H	11.25	11.90	11.67	12.28	12.69	11.10	11.75	11.52	12.14	12.55
	12H	12.25	12.87	12.68	13.27	13.68	12.04	12.66	12.47	13.06	13.48
4H	2H	7.63	8.37	8.03	8.73	9.10	7.90	8.65	8.30	9.01	9.38
	3H	8.78	9.41	9.21	9.81	10.22	8.91	9.54	9.34	9.94	10.35
	4H	9.90	10.44	10.34	10.86	11.31	9.91	10.45	10.35	10.87	11.32
	6H	11.43	11.90	11.90	12.36	12.81	11.31	11.79	11.78	12.24	12.69
	8H	12.44	12.89	12.93	13.35	13.82	12.26	12.70	12.75	13.16	13.64
	12H	13.67	14.08	14.16	14.53	15.05	13.43	13.84	13.92	14.29	14.82
8H	4H	10.30	10.75	10.79	11.21	11.68	10.31	10.75	10.80	11.21	11.69
	6H	12.16	12.53	12.67	13.01	13.52	12.05	12.41	12.56	12.89	13.41
	8H	13.45	13.75	13.99	14.28	14.77	13.28	13.58	13.81	14.10	14.60
	12H	14.94	15.17	15.49	15.68	16.21	14.72	14.94	15.26	15.46	15.99
12H	4H	10.44	10.85	10.93	11.30	11.82	10.45	10.86	10.94	11.31	11.84
	6H	12.47	12.77	13.01	13.29	13.79	12.37	12.67	12.91	13.19	13.69
	8H	13.84	14.07	14.39	14.59	15.11	13.68	13.91	14.23	14.43	14.95
Variation with the observer position at spacings:											
S = 1.0H	2.5/-1.7					2.5/-1.7					
S = 1.5H	3.0/-1.6					3.0/-1.6					
S = 2.0H	3.3/-1.4					3.3/-1.4					
Standard tables:	BKBF					BKBF					
Uncorrected UGR	-3.2					-3.2					

依据CIE Publ. 117 计算 UGR, S/H = 0.25



lumini Solucoes em Iluminacao LTDA
www.lumini.com.br
Email:laboratorio@lumini.com.br
Tel:+55 11 3437-5555 Fax:+55 11 3437-5555
Address:Rua Ferreira Viana, 716 - Socorro - São Paulo/SP

lumini

LumCAT:

Luminaire: no frame concentra flex 17 serie 3 e fa

LampCAT: modulo led 12W 30K irc 90

Ballast type: led driver 700mA

Report No:

Voltage(V): 221.0000

Test No:

Current(A): 0.0640

Number of Lamps: 1

Power (W): 13.9500

Lamp flux(lm): 1290.0

PF: 0.9700

Length(mm): 145

Width(mm): 20

Phm Type: C

Height(mm): 0

Photometric Results

Lumens(lm): 808.47, Efficiency(%): 62.67% , Luminous Efficacy(lm/W): 57.96

Central intensity(cd): 1359.837, Maximum intensity(cd): 1359.837

Angle of maximum intensity: C=0.0 γ =0.0

Beam angle of C0 plane : 44.56

Aveage BeamAngle(IEC 61341):44.56

Equipment: equipamento lumini
Temperature(°C): 25.5

Date: 8/7/2024
Humidity(%): 55.0%

Operator: 01
Distance(m): 6.90

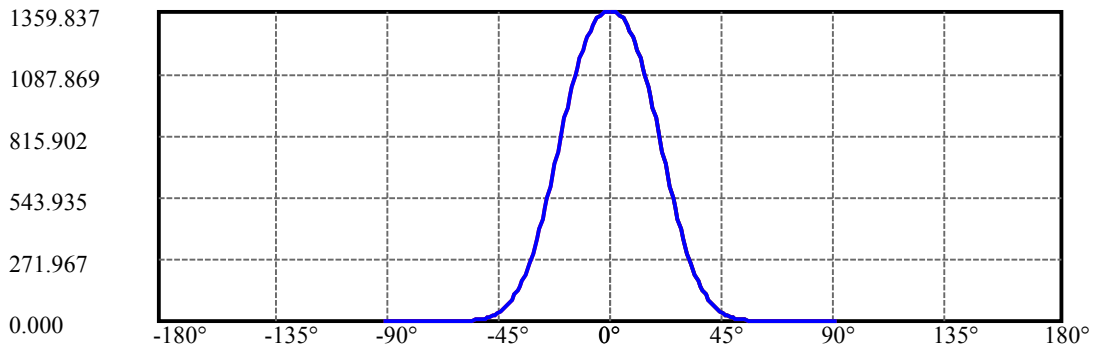
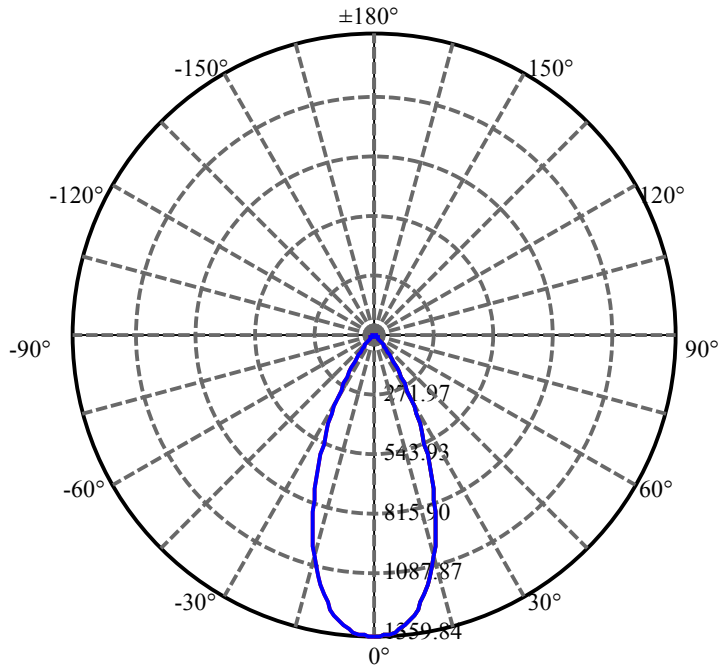

C0(Max): —————
C0/C180: —————
C90/C270: —————

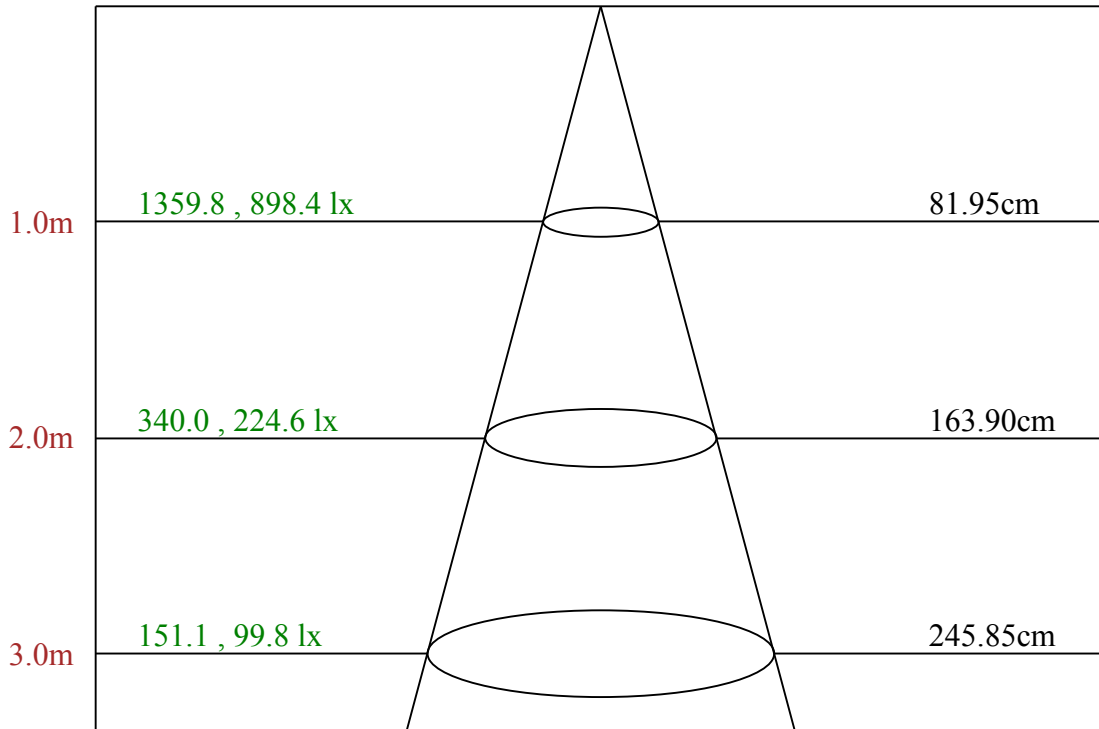

Max , Ave Beam angle of C0 plane 44.56

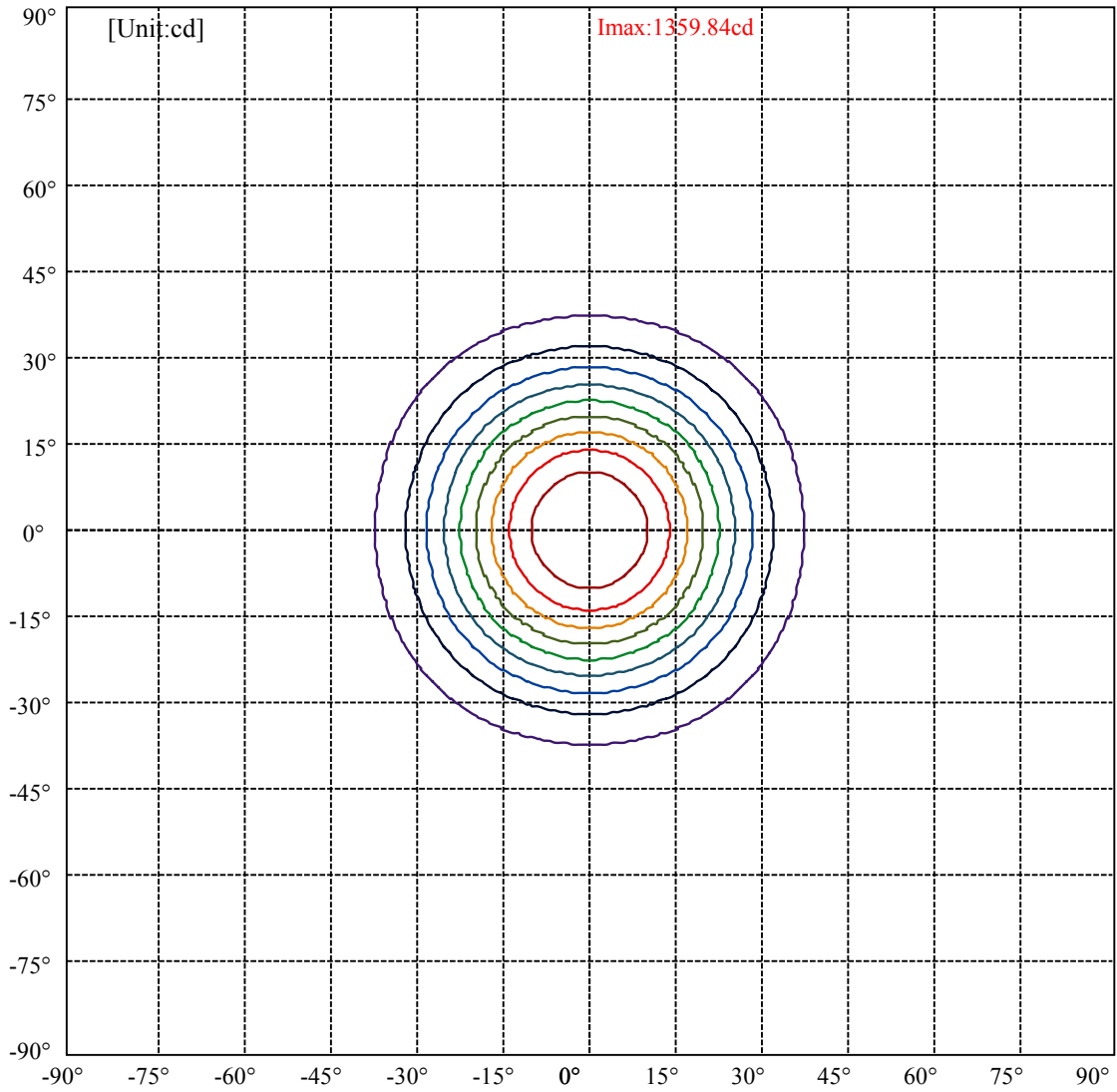

(10%Imax) 135.984	—
(20%Imax) 271.967	—
(30%Imax) 407.951	—
(40%Imax) 543.935	—
(50%Imax) 679.918	—
(60%Imax) 815.902	—
(70%Imax) 951.886	—
(80%Imax) 1087.87	—
(90%Imax) 1223.85	—

lumini

Luminance Limiting Curve(no luminous side)

Luminance Table

γ	45	50	55	60	65	70	75	80	85
C0	16270	6245	2476	1872	1923	2160	2712	4018	8006
C45	16270	6245	2476	1872	1923	2160	2712	4018	8006
C90	16270	6245	2476	1872	1923	2160	2712	4018	8006

L(Hor)(65)	L(Ver)(65)	L45(65)	L(Hor)(75)	L(Ver)(75)	L45(75)	L(Hor)(85)	L(Ver)(85)	L45(85)
1923	1923	1923	2712	2712	2712	8006	8006	8006

Glare Table

Glare	Quality	Service Values Illuminance(lx)							
1.15	A	2000	1000	500	<=300				
1.5	B		2000	1000	500	<=300			
1.85	C			2000	1000	500	<=300		
2.2	D				2000	1000	500	<=300	
2.55	E					2000	1000	500	<=300
		a	b	c	d	e	f	g	h

Luminance Limiting Curve

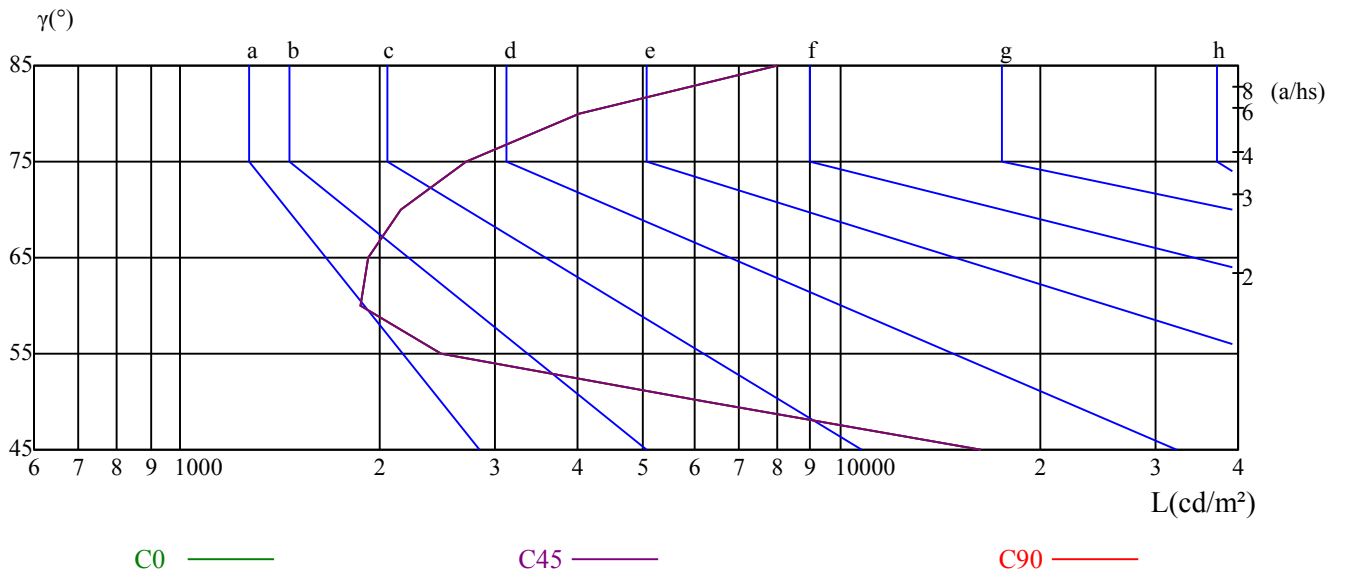

Illumination assessment according UGR											
Rf of Ceiling	70	70	50	50	30	70	70	50	50	30	
Rf of Wall	50	30	50	30	30	50	30	50	30	30	
Rf of Floor	20	20	20	20	20	20	20	20	20	20	
Room dimensions		Viewed crosswise					Viewed endwise				
X	Y										
2H	2H	17.23	18.18	17.60	18.49	18.81	17.84	18.78	18.20	19.09	19.41
	3H	17.06	17.90	17.45	18.24	18.58	17.66	18.50	18.05	18.84	19.19
	4H	16.99	17.77	17.39	18.12	18.49	17.60	18.37	18.00	18.73	19.10
	6H	16.98	17.69	17.40	18.06	18.46	17.58	18.29	18.00	18.67	19.07
	8H	16.97	17.65	17.39	18.03	18.44	17.57	18.25	18.00	18.64	19.04
	12H	17.01	17.65	17.43	18.04	18.46	17.61	18.25	18.04	18.65	19.06
4H	2H	16.93	17.71	17.33	18.06	18.43	17.53	18.30	17.93	18.66	19.03
	3H	16.74	17.39	17.17	17.78	18.20	17.34	17.99	17.76	18.38	18.80
	4H	16.73	17.29	17.17	17.71	18.16	17.33	17.89	17.76	18.31	18.76
	6H	16.72	17.22	17.20	17.67	18.13	17.32	17.81	17.79	18.27	18.72
	8H	16.79	17.25	17.28	17.71	18.18	17.38	17.84	17.87	18.30	18.77
	12H	16.94	17.36	17.43	17.82	18.34	17.53	17.95	18.02	18.40	18.92
8H	4H	16.58	17.03	17.06	17.49	17.97	17.16	17.62	17.65	18.08	18.55
	6H	16.64	17.01	17.14	17.49	18.00	17.21	17.59	17.72	18.07	18.58
	8H	16.83	17.14	17.37	17.67	18.16	17.40	17.71	17.93	18.24	18.73
	12H	17.11	17.35	17.66	17.87	18.40	17.67	17.91	18.22	18.43	18.95
12H	4H	16.54	16.96	17.03	17.42	17.94	17.12	17.55	17.62	18.00	18.52
	6H	16.67	16.99	17.21	17.51	18.01	17.24	17.55	17.78	18.08	18.58
	8H	16.88	17.12	17.42	17.64	18.16	17.43	17.67	17.98	18.19	18.72
Variation with the observer position at spacings:											
S = 1.0H	5.0/-10.0					5.0/-10.0					
S = 1.5H	7.5/-8.2					7.5/-8.2					
S = 2.0H	9.3/-6.9					9.3/-6.9					
Standard tables:	BK1					BK1					
Uncorrected UGR	-0.9					-0.9					

依据CIE Publ. 117 计算 UGR, S/H = 0.25

no frame

no frame concentra flex 17 serie 3

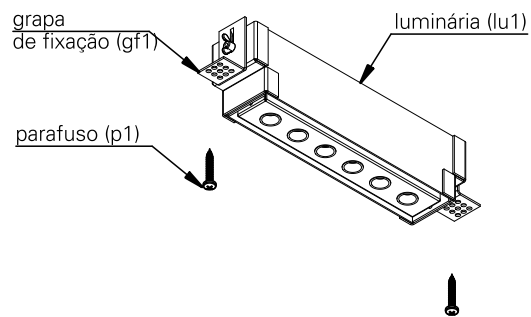

especificações técnicas

fonte de luz
módulo led integrado (incluso)

índice de proteção
IP20 - luminária para uso interno

peso
no frame concentra flex 17 serie 3 - xxx kg

cuidados com o produto
o produto deve ser manuseado com cuidado para evitar riscos e deformações.

para limpeza, utilize detergente neutro e um pano de algodão macio. finalize com um pano de algodão seco.

instalação

conteúdo da embalagem
1 luminária

ferramentas necessárias
chave philips

informações importantes
para a instalação, lave as mãos e seque as mãos, use luvas descartáveis.

antes de iniciar a instalação, certifique-se que a energia elétrica esteja desligada.

retire a luminária da embalagem com cuidado e apoie-o em uma superfície limpa e seca.

atenção

leia atentamente todas as instruções relacionadas ao seu produto antes de utilizá-lo.

antes de iniciar a instalação, certifique-se que a energia elétrica esteja desligada.

não são permitidas modificações no produto, esse deve atender à finalidade para a qual foi projetado e ser utilizado de acordo com as especificações técnicas.

em caso de dúvidas, entre em contato com o fabricante.

instalação passo a passo

1. faça um nicho no forro conforme a tabela abaixo: no frame concentra flex 17 serie 3 - nicho = 171x44

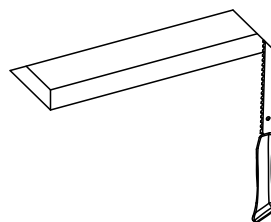

2. faça a ligação elétrica. isole os fios separadamente com fita isolante. repita a operação envolvendo o conjunto dos fios, vedando completamente a emenda.

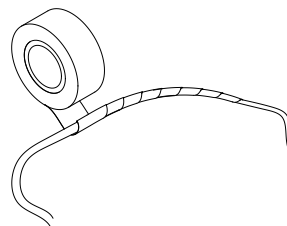

3. ajuste a grapa de fixação (gf1) conforme a espessura do forro.

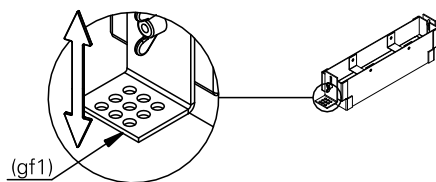

4. encline a luminária (lu1) para entrar no nicho e posicione na posição adequada.

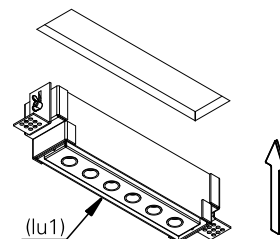

5. utilize os parafusos (p1) para fixar o corpo (co1) e de o acabamento no forro com gesso, não deixando o parafuso aparente. espere a secagem do gesso para prosseguir a próxima etapa.

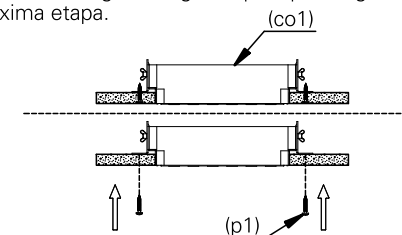

6. para orientar o fecho de luz, mova a luminária (lu1) para os lados conforme indicado.

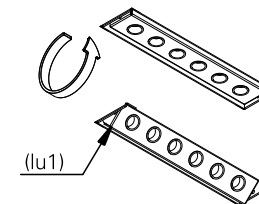

7. a luminária após instalada deverá ficar como ilustrado na imagem. ligue a rede elétrica e teste o seu funcionamento.

