



# norte/sul

design sol camacho

desenhada por sol camacho para a lumini, norte/sul é uma luminária pendente que possibilita a movimentação da cúpula em torno do seu eixo, pelo usuário, para direcionar o fecho de luz, permitindo uma iluminação direta ou indireta.

## informações técnicas

fonte de luz  
LED integrado

IRC  
alto índice de reprodução de cor (irc>90 | r9>60)

vida útil  
50.000h

potência (W), fecho, temperatura de cor (K),  
fluxo nominal (lm nominal), fluxo útil (lm útil)

W	☀️	K	lm nominal	lm útil
21		2500		

equipamentos  
LED driver

controle  
on/off  
dim fphase

instalação  
forro de gesso  
laje  
marcenaria

IP  
20

## dimensões

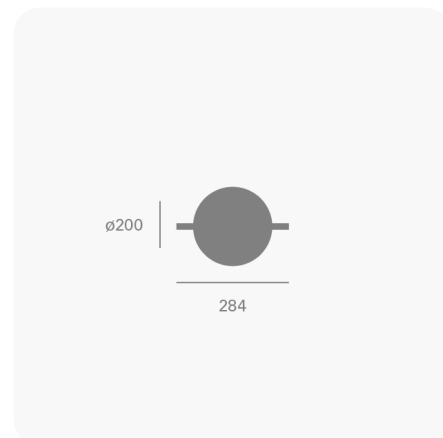
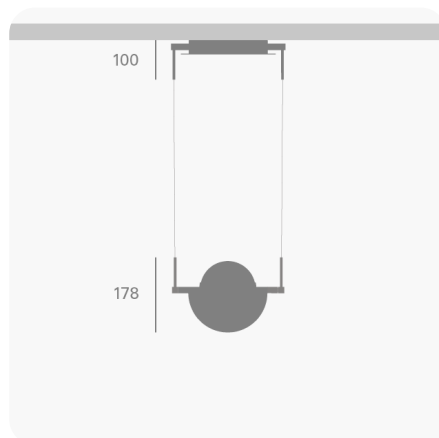

## acabamentos e cores

### cores

verde selva	cinza areia
verde índico	branco txt
titânio	phosphorus
azul petróleo	verde sálvia
grafite txt	vermelho
off black	off white
bege	goiaba
laranja	rosa nude

preto txt	corten
azul sp	cinza médio
marinho	carbono
terracota	azul médio
champagne	amarelo
rosa médio	

---



## norte/sul

design sol camacho  
iF design award

desenhada por sol camacho para a lumini, norte/sul é uma luminária pendente que possibilita a movimentação da cúpula em torno do seu eixo, pelo usuário, para direcionar o fecho de luz, permitindo uma iluminação direta ou indireta.

### informações técnicas

fonte de luz  
LED integrado

IRC  
alto índice de reprodução de cor (irc>90 | r9>60)

vida útil  
50.000h

### facho

concentrado (10 a 20°)  
médio (21 a 45°)  
aberto (> 46°)  
difuso

potência	facho	temperatura de...	fluxo luminoso...	fluxo luminoso útil	dimensões
21		2500			

equipamentos  
LED driver

controle  
on/off  
dim fphase

instalação  
forro de gesso  
laje  
marcenaria

IP  
20

### dimensões

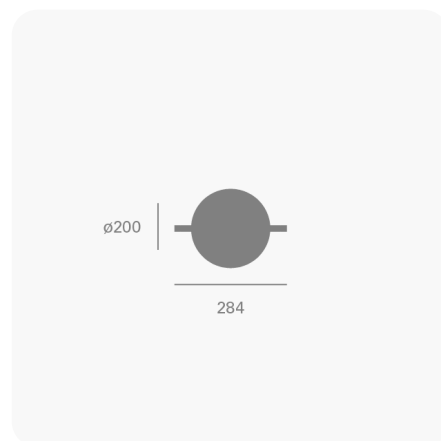
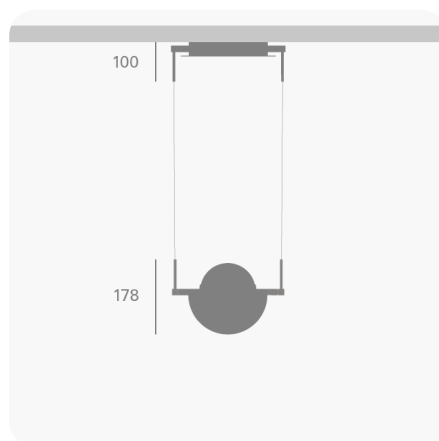

### acabamentos e cores

#### cores



	azul petróleo		verde sálvia
	grafite txt		vermelho
	off black		off white
	bege		goiaba
	laranja		rosa nude
	preto txt		corten
	azul sp		cinza médio
	marinho		carbono
	terracota		azul médio
	champagne		amarelo
	rosa médio		

---



## norte/sul

design sol camacho  
iF design award

desenhada por sol camacho para a lumini, norte/sul é uma luminária pendente que possibilita a movimentação da cúpula em torno do seu eixo, pelo usuário, para direcionar o fecho de luz, permitindo uma iluminação direta ou indireta.

### informações técnicas

fonte de luz  
LED integrado

IRC  
alto índice de reprodução de cor (irc>90 | r9>60)

vida útil  
50.000h

### facho

concentrado (10 a 20°)  
médio (21 a 45°)  
aberto (> 46°)  
difuso

potência	facho	temperatura de...	fluxo luminoso...	fluxo luminoso útil	dimensões
21		2500			

equipamentos  
LED driver

controle  
on/off  
dim fphase

instalação  
forro de gesso  
laje  
marcenaria

IP  
20

### dimensões

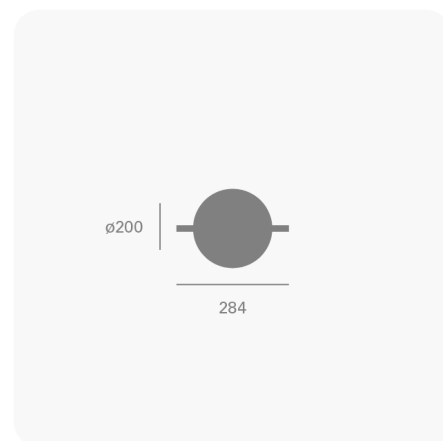
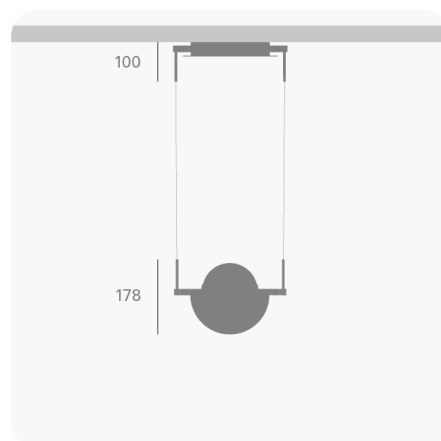

### acabamentos e cores

#### cores



	azul petróleo		verde sálvia
	grafite txt		vermelho
	off black		off white
	bege		goiaba
	laranja		rosa nude
	preto txt		corten
	azul sp		cinza médio
	marinho		carbono
	terracota		azul médio
	champagne		amarelo
	rosa médio		

---



## norte/sul

design sol camacho  
iF design award

desenhada por sol camacho para a lumini, norte/sul é uma luminária pendente que possibilita a movimentação da cúpula em torno do seu eixo, pelo usuário, para direcionar o fecho de luz, permitindo uma iluminação direta ou indireta.

### informações técnicas

fonte de luz  
LED integrado

IRC  
alto índice de reprodução de cor (irc>90 | r9>60)

vida útil  
50.000h

### facho

concentrado (10 a 20°)  
médio (21 a 45°)  
aberto (> 46°)  
difuso

potência	facho	temperatura de...	fluxo luminoso...	fluxo luminoso útil	dimensões
21		2500			

equipamentos  
LED driver

controle  
on/off  
dim fphase

instalação  
forro de gesso  
laje  
marcenaria

IP  
20

### dimensões

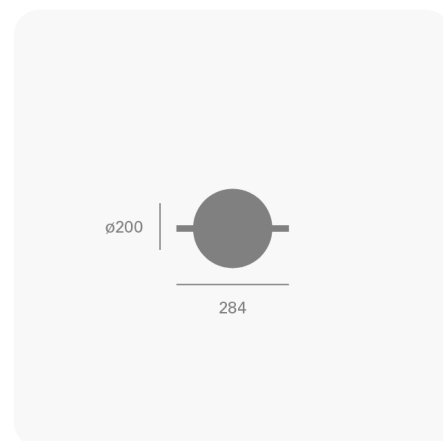
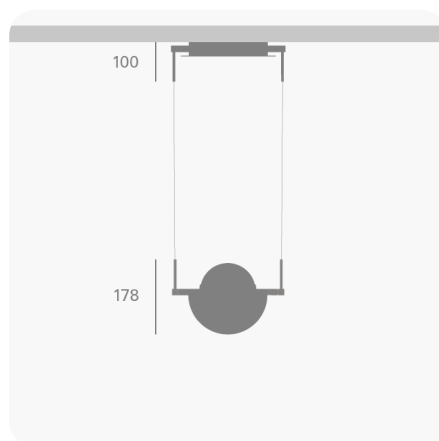

### acabamentos e cores

#### cores



	azul petróleo		verde sálvia
	grafite txt		vermelho
	off black		off white
	bege		goiaba
	laranja		rosa nude
	preto txt		corten
	azul sp		cinza médio
	marinho		carbono
	terracota		azul médio
	champagne		amarelo
	rosa médio		

---



## norte/sul

design sol camacho  
iF design award

desenhada por sol camacho para a lumini, norte/sul é uma luminária pendente que possibilita a movimentação da cúpula em torno do seu eixo, pelo usuário, para direcionar o fecho de luz, permitindo uma iluminação direta ou indireta.

### informações técnicas

fonte de luz  
LED integrado

IRC  
alto índice de reprodução de cor (irc>90 | r9>60)

vida útil  
50.000h

### facho

concentrado (10 a 20°)  
médio (21 a 45°)  
aberto (> 46°)  
difuso

potência	facho	temperatura de...	fluxo luminoso...	fluxo luminoso útil	dimensões
21		2500			

equipamentos  
LED driver

controle  
on/off  
dim fphase

instalação  
forro de gesso  
laje  
marcenaria

IP  
20

### dimensões

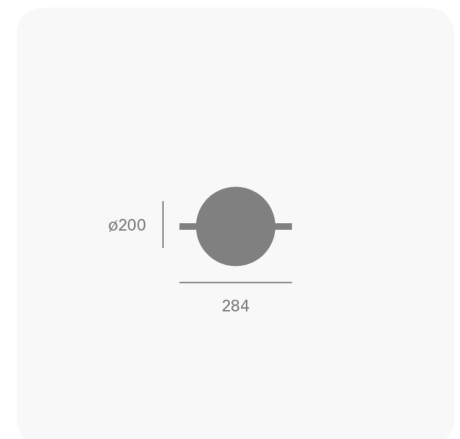
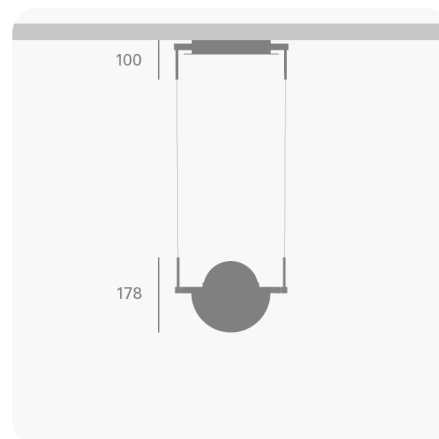

### acabamentos e cores

#### cores



	azul petróleo		verde sálvia
	grafite txt		vermelho
	off black		off white
	bege		goiaba
	laranja		rosa nude
	preto txt		corten
	azul sp		cinza médio
	marinho		carbono
	terracota		azul médio
	champagne		amarelo
	rosa médio		

---



## norte/sul

design sol camacho  
iF design award

desenhada por sol camacho para a lumini, norte/sul é uma luminária pendente que possibilita a movimentação da cúpula em torno do seu eixo, pelo usuário, para direcionar o fecho de luz, permitindo uma iluminação direta ou indireta.

### informações técnicas

fonte de luz  
LED integrado

IRC  
alto índice de reprodução de cor (irc>90 | r9>60)

vida útil  
50.000h

### facho

concentrado (10 a 20°)  
médio (21 a 45°)  
aberto (> 46°)  
difuso

potência	facho	temperatura de...	fluxo luminoso...	fluxo luminoso útil	dimensões
21		2500			

equipamentos  
LED driver

controle  
on/off  
dim fphase

instalação  
forro de gesso  
laje  
marcenaria

IP  
20

### dimensões

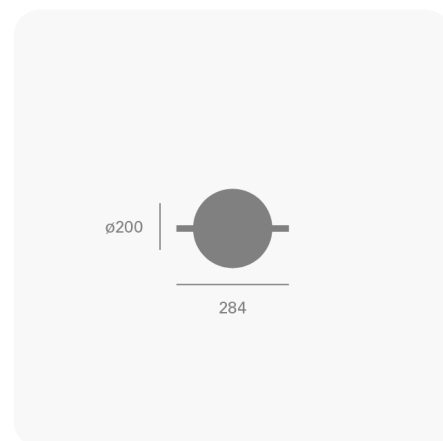
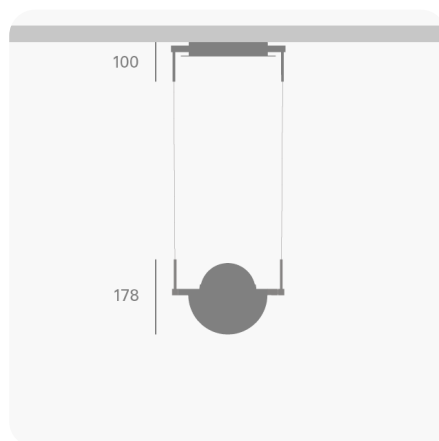

### acabamentos e cores

#### cores



	azul petróleo		verde sálvia
	grafite txt		vermelho
	off black		off white
	bege		goiaba
	laranja		rosa nude
	preto txt		corten
	azul sp		cinza médio
	marinho		carbono
	terracota		azul médio
	champagne		amarelo
	rosa médio		

---

## vista frontal

dimensões em milímetros

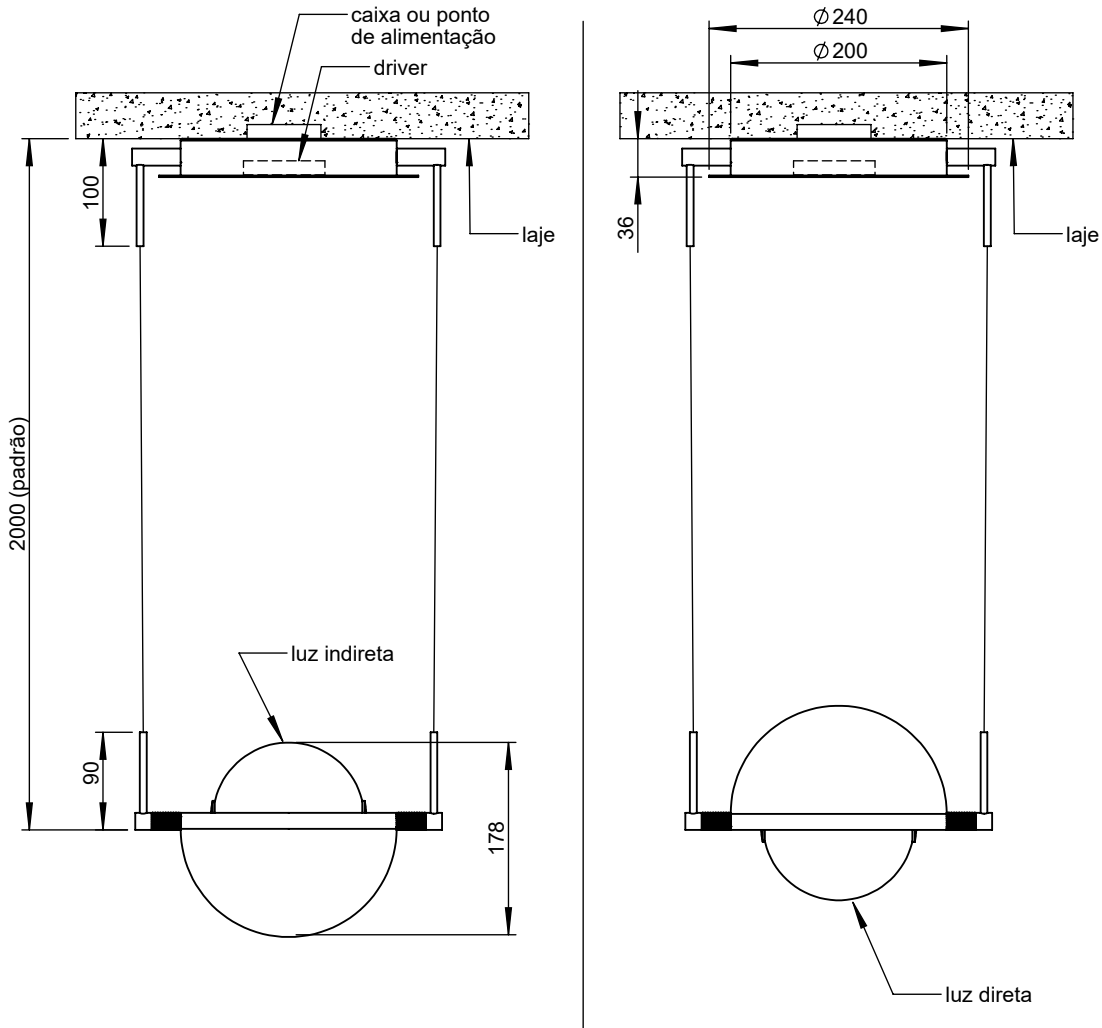

## norte sul s

folha  
1/1

escala  
1:7

data  
16/05/2023

desenhista  
emilson

aprovação  
edmilson

revisões  
16/05/2023

para maiores informações,  
consulte a área técnica  
produto@lumini.com.br

## vista superior

dimensões em milímetros

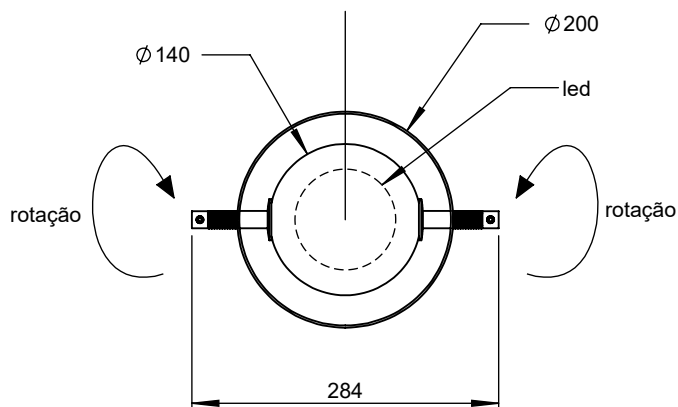

## norte sul

norte sul s

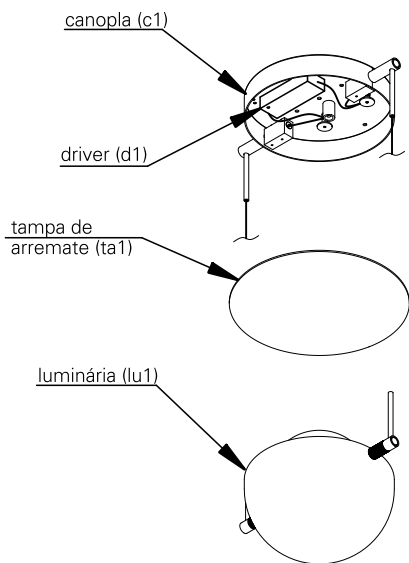

### atenção

leia atentamente todas as instruções relacionadas ao seu produto antes de utilizá-lo.

antes de iniciar a instalação, certifique-se que a energia elétrica esteja desligada.

não são permitidas modificações no produto, esse deve atender à finalidade para a qual foi projetado e ser utilizado de acordo com as especificações técnicas.

em caso de dúvidas, entre em contato com o fabricante.

[lumini.com.br](http://lumini.com.br)

### especificações técnicas

#### fonte de luz

módulo led integrado (incluso)

#### índice de proteção

IP20 - luminária para uso interno

#### peso

norte sul s -1,2 kg

#### cuidados com o produto

o produto deve ser manuseado com cuidado para evitar riscos e deformações.

para limpeza, utilize detergente neutro e um pano de algodão macio. finalize com um pano de algodão seco.

#### instalação

#### conteúdo da embalagem

1 luminária  
2 parafusos

#### ferramentas necessárias

chave philips  
furadeira

#### informações importantes

para a instalação, lave as mãos e seque as mãos, use luvas descartáveis.

retire a luminária da embalagem com cuidado e apoie-o em uma superfície limpa e seca.

# instalação passo a passo

**1.** desrosqueie a tampa de arremate (ta1) da canopla (c1).

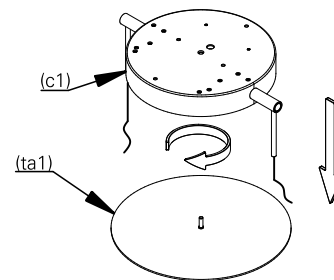

**2.** utilize o parafusos (p1) para fixar a canopla (c1) no local.

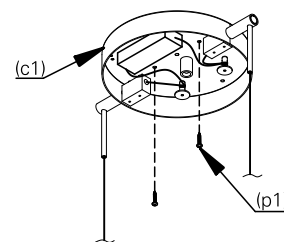

**3.** faça a ligação elétrica. isole os fios separadamente com fita isolante. repita a operação envolvendo o conjunto dos fios, vedando completamente a emenda.

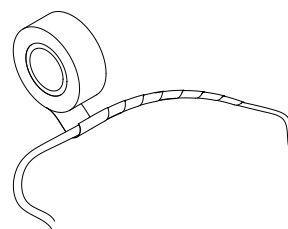

**4.** para regular a altura da luminária, folge os parafusos (p2) e enrole o cabo (cb1) nos distanciadores (dt1).

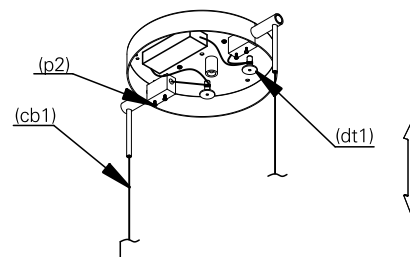

**5.** rosqueie a tampa de arremate (ta1) na canopla (c1).

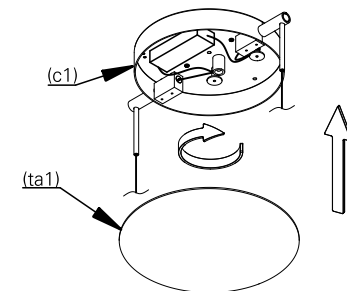

**6.** para orientar o fecho de luz, gira a bucha recartilhada (br1) para os lados conforme indicado.

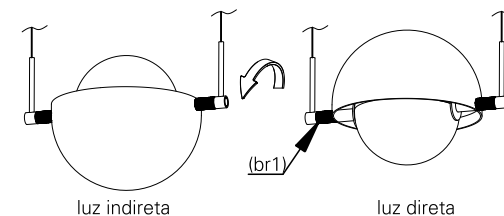

**7.** a luminária após instalada deverá ficar como ilustrado na imagem. ligue a rede elétrica e teste o seu funcionamento.

